

# The Use of HBr in Polysilicon Etching

BY MATTHEW L. WAGNER, PH.D. AND ROB NINE

## Introduction

This article discusses the role of hydrogen bromide (HBr) in the etching of polysilicon and the effects of HBr purification in this process. First, the basics of semiconductor etching and plasma etching are reviewed. Next, the use of HBr in polysilicon etching and the specific effects of moisture in the HBr are described. Lastly, the benefits of HBr gas purification are discussed.

## Etch Basics

Etching is an intermediate semiconductor processing step in which material is removed from the surface of a wafer by exposing the wafer to gas phase or liquid phase chemicals. The basic process is simple:

- 1) Expose the wafer to the etchant.
- 2) The etchant interacts chemically and/or physically with the wafer surface.
- 3) The material produced from this interaction is removed from the surface.

Etching can be either patterned or unpatterned. When patterned, etch is combined with photolithography. The areas not protected by the photoresist are etched and the pattern is incised into the wafer. This is illustrated in Figure 1. When unpatterned, the etching takes place over the entire wafer surface. This is done to remove masking layers and for wafer cleaning.

The etch performance characteristics of most concern are selectivity and profile. If the process is completely selective, only the desired material is removed. If the process is non-selective, it removes both desired and undesired material. This is illustrated in Figure 2.

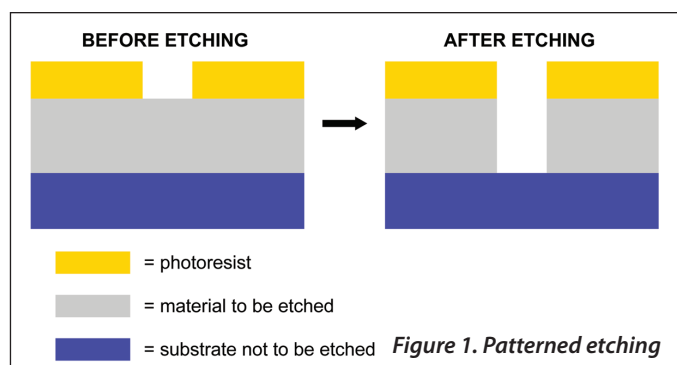

Etch profile describes the shape of the etched feature and the associated level of control of the critical dimension in the desired pattern. The profile (and etch process) is typically described as being either anisotropic or isotropic. When anisotropic, the etch rate is greater vertically through the wafer than horizontally across it. This allows for high aspect ratio features to be formed. When isotropic, the etching is uniform in all dimensions which results in undercutting. This is illustrated in Figure 3.

Other important performance characteristics include throughput, cost, safety, and ease of operation. Costs include capital, operation, and maintenance. Safety includes chemical handling and waste disposal. Ease of operation includes simplicity and process control.

Etching is done either “wet” or “dry”. Wet processes use liquid phase chemicals, usually mixtures of acids, bases, and/or solvents. The surface material is removed chemically. Dry processes use plasmas formed from gases. The surface material is removed physically or chemically or by a combination of both.

The advantages of wet etch over dry etch are higher selectivity, higher throughput (typically multi-wafer batches), lower costs, and a simpler process (an immersion tank followed by rinsing and drying steps). The disadvantages are an isotropic profile and significant chemical and waste handling. Because of the isotropic profile, wet etch is limited to patterning only very large critical dimensions (> 3 μm), removing masks, and cleaning.

The advantages of dry processes are an anisotropic profile, less chemical and waste handling, and excellent process control (there are many finely adjustable process parameters). The disadvantages are a lower selectivity, lower throughput (usually single wafer), and higher total costs. Because of its anisotropic profile and the need to produce patterns with critical dimensions much smaller than 3 μm, dry etch is used for most pattern transfer.

## Plasma Etching

Dry etching uses plasma as the etchant. Plasma is a partially ionized gas that is electrically neutral overall. Plasmas are composed of ions (usually positively charged), energetic free radicals (uncharged reactive molecular fragments), electrons, and photons. They are generated by applying electric and/or magnetic fields to a gas.

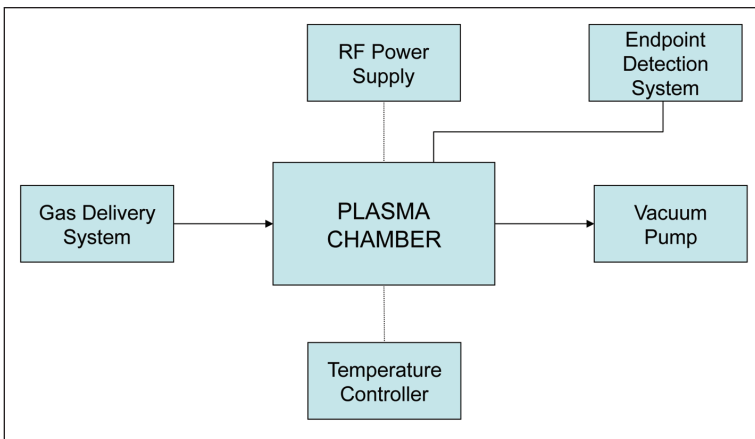
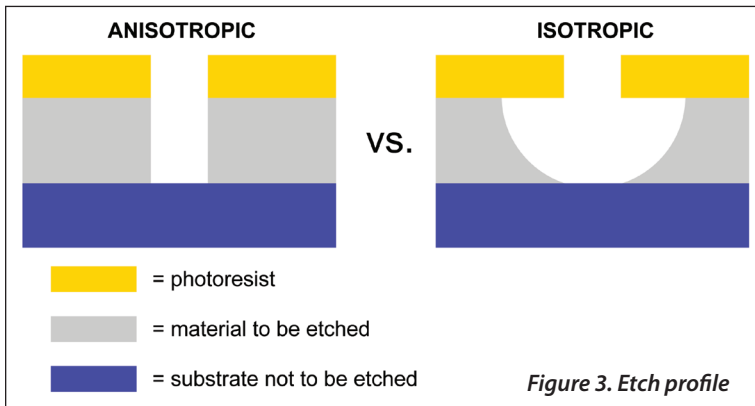
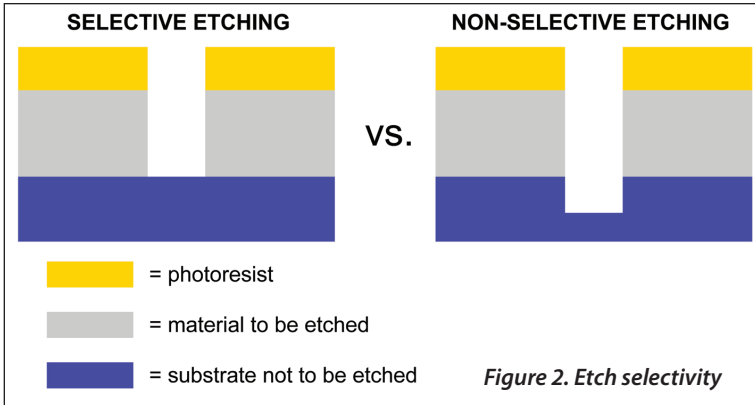

Figure 4. Plasma etch system schematic (based on Figure 4 p. 148 from Reference #2)

In plasma etching, a strong RF electromagnetic field is typically used to form the plasma. The pressure in the plasma chamber is low, typically less than 5 Torr and often in the milliTorr range. A general schematic of a plasma etch system is shown in Figure 4.

There are three main types of plasma etching: sputter etch, chemical etch, and reactive ion etch. These are illustrated individually in Figures 5, 6, and 7. Sputter etch is a purely physical process that bombards the wafer surface with

non-reactive ions to eject surface material. It is highly anisotropic, but with a low selectivity and etch rate. Chemical etch is a purely chemical process that uses neutral free radicals to react with surface material to form volatile products. It is highly selective, but isotropic. Reactive ion etch combines the two and uses ion bombardment to promote surface chemical reactions. This produces etches that are both anisotropic and selective.

The gas used to form the plasma is

typically a multi-component gas mixture. The recipes used are proprietary and depend on the plasma etch tool and the specific application. However, in general, the gas mixture contains small molecules rich in Cl or F atoms. Table 1 summarizes the etch chemistries typically used.

### Use of HBr in Plasma Etching

HBr is used primarily to etch silicon. Typically, it is used alongside Cl<sub>2</sub> and O<sub>2</sub>. HBr modifies both the plasma chemistry and the surface chemistry of the

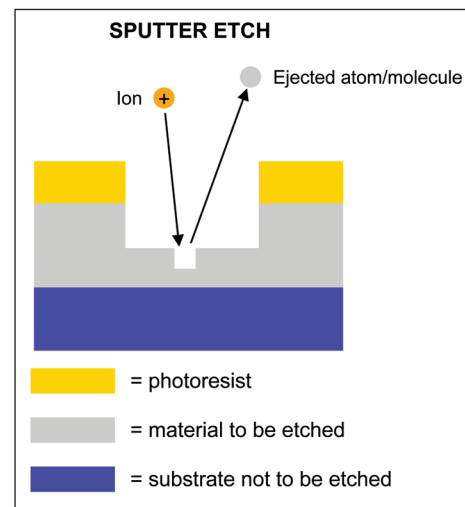

Figure 5. Sputter etch process (based on an illustration on slide 21 from Reference #1)

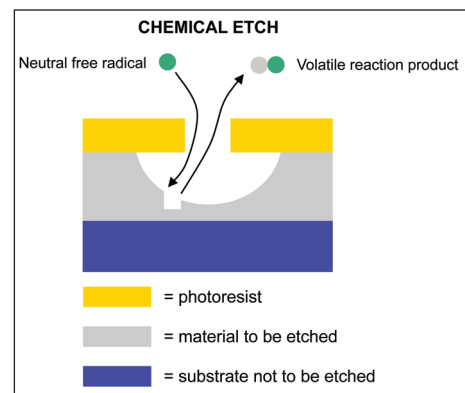

Figure 6. Chemical etch process (based on an illustration on slide 20 from Reference #1)

process which, in turn, changes etch performance. Most critically, adding HBr makes the profile more anisotropic than when using Cl<sub>2</sub> alone. HBr is also very selective. One drawback is that it

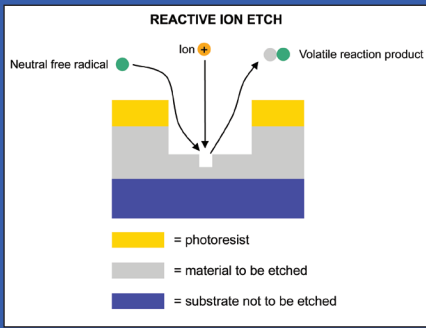

Figure 7. Reactive ion etch process (based on an illustration on slide 22 from Reference #1)

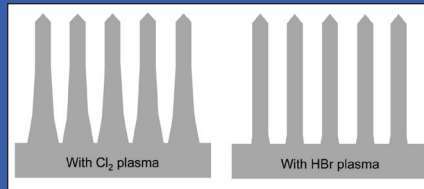

Figure 8. Polysilicon etch profiles:  $Cl_2$  versus HBr (based on micrographs in Figure 13 from Reference #5)

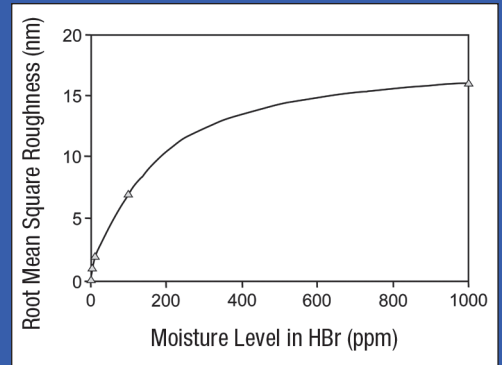

Figure 9. Growth of surface roughness with moisture (based on Figure 8 from Reference #13)

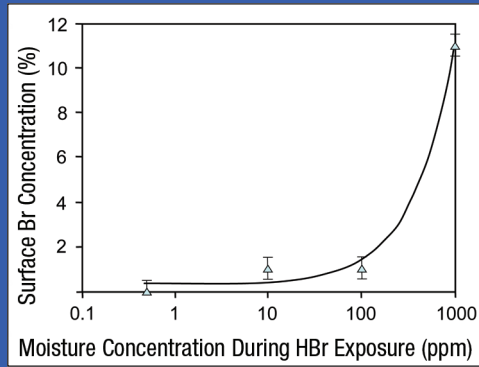

Figure 10. Growth of Br incorporation with moisture (based on Figure 3 from Reference #14)

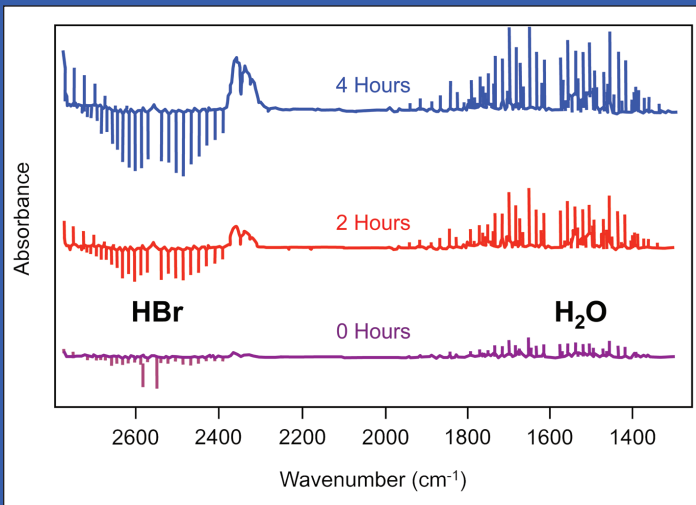

Figure 11. Moisture generation during HBr corrosion (based on Figure 8 from reference #14)

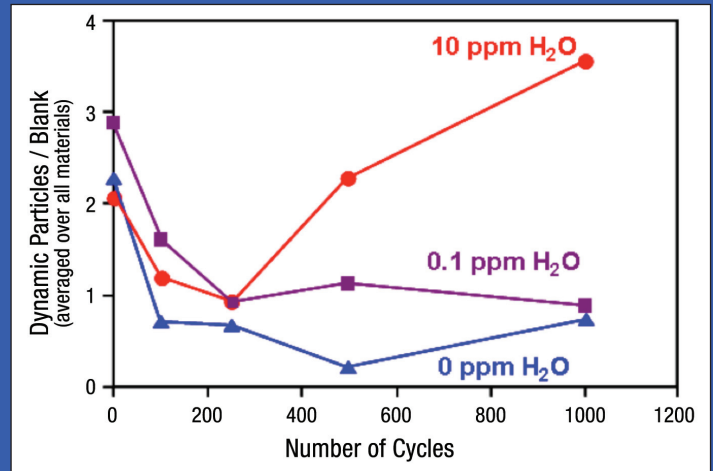

Figure 12. Particle formation from HBr corrosion (based on Figure 41 from reference #15)

| Material Being Etched          | Chemistry      | Etch Gases   |
|--------------------------------|----------------|--|
| Deep Si trench                 | F based        | HBr/NF <sub>3</sub> /O <sub>2</sub> /SF <sub>6</sub>   |
| Shallow Si trench              | Cl based       | HBr/Cl <sub>2</sub> /O <sub>2</sub>  |
| Poly Si                        | Cl and F based | HBr/Cl <sub>2</sub> /O <sub>2</sub> , HBr/O <sub>2</sub> , BCl <sub>3</sub> /Cl <sub>2</sub> , SF <sub>6</sub>   |
| SiO <sub>2</sub>               | F based        | CF <sub>4</sub> /O <sub>2</sub> , CF <sub>4</sub> /CHF <sub>3</sub> /Ar, C <sub>2</sub> F <sub>6</sub> , C <sub>3</sub> F <sub>8</sub> , C <sub>4</sub> F <sub>8</sub> /CO, C <sub>5</sub> F <sub>8</sub> , CH <sub>2</sub> F <sub>2</sub> |
| Si <sub>3</sub> N <sub>4</sub> | F based        | CF <sub>4</sub> /O <sub>2</sub> , CHF <sub>3</sub> /O <sub>2</sub> , CH <sub>2</sub> F <sub>2</sub> , CH <sub>2</sub> CHF <sub>2</sub>   |
| Al                             | Cl based       | BCl <sub>3</sub> /Cl <sub>2</sub> , SiCl <sub>4</sub> /Cl <sub>2</sub> , HBr/Cl <sub>2</sub>   |
| Other metals                   | Cl and F based | SF <sub>6</sub> , NF <sub>3</sub> /Cl <sub>2</sub> , CF <sub>4</sub> , C <sub>2</sub> F <sub>6</sub> , Cl <sub>2</sub> , BCl <sub>3</sub> , CCl <sub>4</sub>   |
| Organics                       | O based        | O <sub>2</sub> , CF <sub>4</sub> /O <sub>2</sub> , O <sub>2</sub> /SF <sub>6</sub>   |

| Element    | Concentration           |
|------------|-------------------------|
| Iron       | Balance                 |
| Chromium   | 16 – 18%                |
| Nickel     | 10 – 14%                |
| Molybdenum | 2 – 3%                  |
| Manganese  | 2%                      |
| Silicon    | 0.75% (0.5% for VAR)    |
| Phosphorus | 0.045%                  |
| Carbon     | 0.03%                   |
| Sulfur     | 0.03% (<0.005% for VAR) |
| Nitrogen   | 0.01%                   |

Table 1. Plasma etch chemistries<sup>1,3,4</sup>

Table 3. Typical 316L Specifications<sup>19-22</sup>

| Supplier         | Air Liquide |          |            | Matheson Trigas |           | Air Products | Linde   | Praxair    |
|------------------|-------------|----------|------------|-----------------|-----------|--------------|---------|------------|
| Purity           | 99.999%     | 99.995%  | 99.8%      | 99.9995%        | 99.999%   | 99.8%        | 99.995% | 99.995%    |
| H <sub>2</sub> O | < 1 ppm     | < 1 ppm  | < 50 ppm   | < 1 ppm         | < 1 ppm   | < 70 ppm     |         | < 5 ppm    |
| O <sub>2</sub>   | < 1 ppm     | < 5 ppm  | < 100 ppm  | < 1 ppm         | < 1 ppm   |              |         | < 5 ppm    |
| CO               | < 1 ppm     | < 5 ppm  |            | < 0.5 ppm       | < 0.5 ppm |              |         | < 1 ppm    |
| CO <sub>2</sub>  | < 1 ppm     | < 20 ppm | < 50 ppm   | < 1 ppm         | < 3 ppm   |              |         | < 20 ppm   |
| CH <sub>4</sub>  | < 0.5 ppm   | < 5 ppm  |            | < 1 ppm         | < 1.5 ppm |              |         | < 1 ppm    |
| N <sub>2</sub>   | < 1 ppm     | < 10 ppm | < 400 ppm  | < 1 ppm         | < 3 ppm   |              |         | < 20 ppm   |
| HCl              |             |          | < 1000 ppm | < 50 ppm        |           | < 2000 ppm   |         | < 500 ppmw |
| H <sub>2</sub>   |             |          |            | < 50 ppm        |           |              |         |            |
| Cr               | < 50 ppbw   |          |            | < 5 ppbw        |           |              |         |            |
| Cu               | < 25 ppbw   |          |            | < 1 ppbw        |           |              |         |            |
| Fe               | < 150 ppbw  |          |            | < 10 ppbw       |           |              |         | < 1 ppmw   |
| Mg               | < 25 ppbw   |          |            | < 1 ppbw        |           |              |         |            |
| Mn               | < 25 ppbw   |          |            | < 1 ppbw        |           |              |         |            |
| Na               | < 25 ppbw   |          |            | < 5 ppbw        |           |              |         |            |
| Ni               | < 50 ppbw   |          |            | < 10 ppbw       |           |              |         |            |
| Al               |             |          |            | < 5 ppbw        |           |              |         |            |
| Ca               |             |          |            | < 5 ppbw        |           |              |         |            |
| Pb               |             |          |            | < 1 ppbw        |           |              |         |            |
| Zn               |             |          |            | < 1 ppbw        |           |              |         |            |

Table 2. HBr specifications (from References # 8-12)

| Moisture Concentration | Effects                            |
|------------------------|------------------------------------|
| 0.5 ppm                | Little reaction observed           |
| 10 ppm                 | Thin Br deposit formed             |
|                        | 1% Br incorporation in 1 m depth   |
|                        | Onset of corrosion                 |
| 100 ppm                | Corrosion pits observed            |
| 1000 ppm               | Dense Br scale formed              |
|                        | 11% Br incorporation in 1 μm depth |

**Table 4. Effects of moisture on HBr corrosion<sup>13</sup>**

slows the etch rate versus using Cl<sub>2</sub> alone. The O<sub>2</sub> is added to the mix to remove organics.

Including HBr in the plasma gas mix results in an improved etch profile. There is less undercut, more vertical sidewalls, and flatter trench bottoms. This is particularly important for high aspect ratio trenches. This is shown in Figure 8. HBr also produces fewer defects. The HBr flow rates used are in the range of tens to hundreds of sccms per tool.

The HBr specifications from several gas suppliers are listed in Table 2. The HBr offered can be divided into three grade categories: ultra-high purity (≥ 99.999%), technical (99.8%), and intermediate (99.995%). Ultrahigh purity HBr has a moisture specification of < 1 ppm, technical HBr < 50 ppm or higher, and intermediate either < 1 ppm or < 5 ppm. For plasma etch applications, ultrahigh or intermediate grades are typically used.

### Problems Associated With Using HBr in Plasma Etching

In the presence of moisture, HBr can corrode the 316L stainless steel that is typically used as the material of construction for a plasma etch tool's gas delivery system. The composition of 316L stainless steel is shown in Table 3. Corrosion can then lead to the formation of both particles and volatile metal compounds. Particle formation can result in particle contamination on the wafer and mechanical failure and leaks in the gas delivery system. Volatile metal compounds can lead to the incorporation of heavy metals such as Fe, Cr, and Ni into the devices being

| Metal (ppb) | Method Zero | Without Purification | With Purification | Method DL |
|-------------|-------------|----------------------|-------------------|-----------|
| Be          | <DL         | <DL                  | <DL               | 0.9       |
| B           | <DL         | <DL                  | <DL               | 3.2       |
| Na          | <DL         | <DL                  | <DL               | 1.5       |
| Mg          | 18.7        | 5.5                  | 8.3               | 0.9       |
| Al          | 9.4         | <DL                  | <2.9*             | 0.8       |
| K           | <DL         | <DL                  | <DL               | 0.8       |
| Ca          | <DL         | <7.8*                | <DL               | 2.7       |
| Ti          | <DL         | <DL                  | <DL               | 2.9       |
| V           | <DL         | <DL                  | <DL               | 0.7       |
| Ce          | <DL         | <DL                  | <DL               | 1.0       |
| Mn          | <DL         | <DL                  | <DL               | 1.3       |
| Fe          | <6.8        | <3.0*                | <3.9              | 1.0       |
| Co          | <DL         | <DL                  | <DL               | 0.3       |
| Ni          | <DL         | <DL                  | <DL               | 1.0       |
| Cu          | <DL         | <DL                  | <DL               | 1.0       |
| Zn          | 3.4*        | <3.4*                | <3.4*             | 1.0       |
| Mo          | <DL         | <DL                  | <DL               | 1.2       |
| Ag          | <DL         | <DL                  | <DL               | 0.9       |
| Ba          | <DL         | <DL                  | <DL               | 0.9       |
| W           | <DL         | <DL                  | <DL               | 1.1       |
| Tl          | <DL         | <DL                  | <DL               | 1.0       |
| Pb          | <DL         | <DL                  | <DL               | 0.9       |

Results in ppb; μ-gm of metal per kg HBr

Method Detection Limit = 3x Standard Deviation (SD)

\* These measurements indicate values < Quantitation Limit (10% SD)

**Table 5. Metal contribution from HBRP purification material**  
(Testing was conducted by Pall SLS.)

built which then serve as deep-level traps that reduce device yield and performance.

HBr can react with both the base metals and the surface metal oxides of 316L. Using reactions with Fe as an example (since Fe is the largest constituent of 316L), the potential corrosion reactions associated with HBr are<sup>15,16</sup>

Reactions with metal:

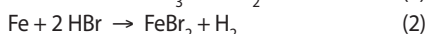
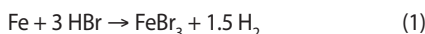

Reactions with metal oxides:

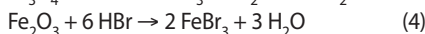
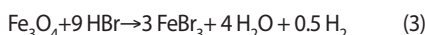

Similar reactions are possible with the other metallic components of 316L, Cr, Ni, Mo, and Mn, as well as with other metals that might be present in the gas delivery system.

Moisture has an important role in these corrosion reactions. First, moisture catalyzes

the reactions above by dissociating HBr on the surface into H<sup>+</sup> and Br<sup>-</sup>. More moisture results in more corrosion. The results of one study on the effect of moisture on corrosion are summarized in Table 4 and shown in Figures 9 and 10<sup>13</sup>. Below 0.5 ppm H<sub>2</sub>O, there was little corrosion. As moisture was increased, so was the corrosion. Figure 9 shows the metal surface becomes rougher with increasing moisture. Figure 10 shows that Br incorporation into the metal increases with increasing moisture.

Moisture is also generated in the corrosion of metal oxides as seen in equations 3 and 4 above. So, as corrosion occurs, more moisture is formed, which, in turn, increases corrosion. The formation of H<sub>2</sub>O during corrosion is shown in Figure 11<sup>14</sup>. In this work, HBr was placed in contact with electropolished 316L and nickel-200 tubing. The gas

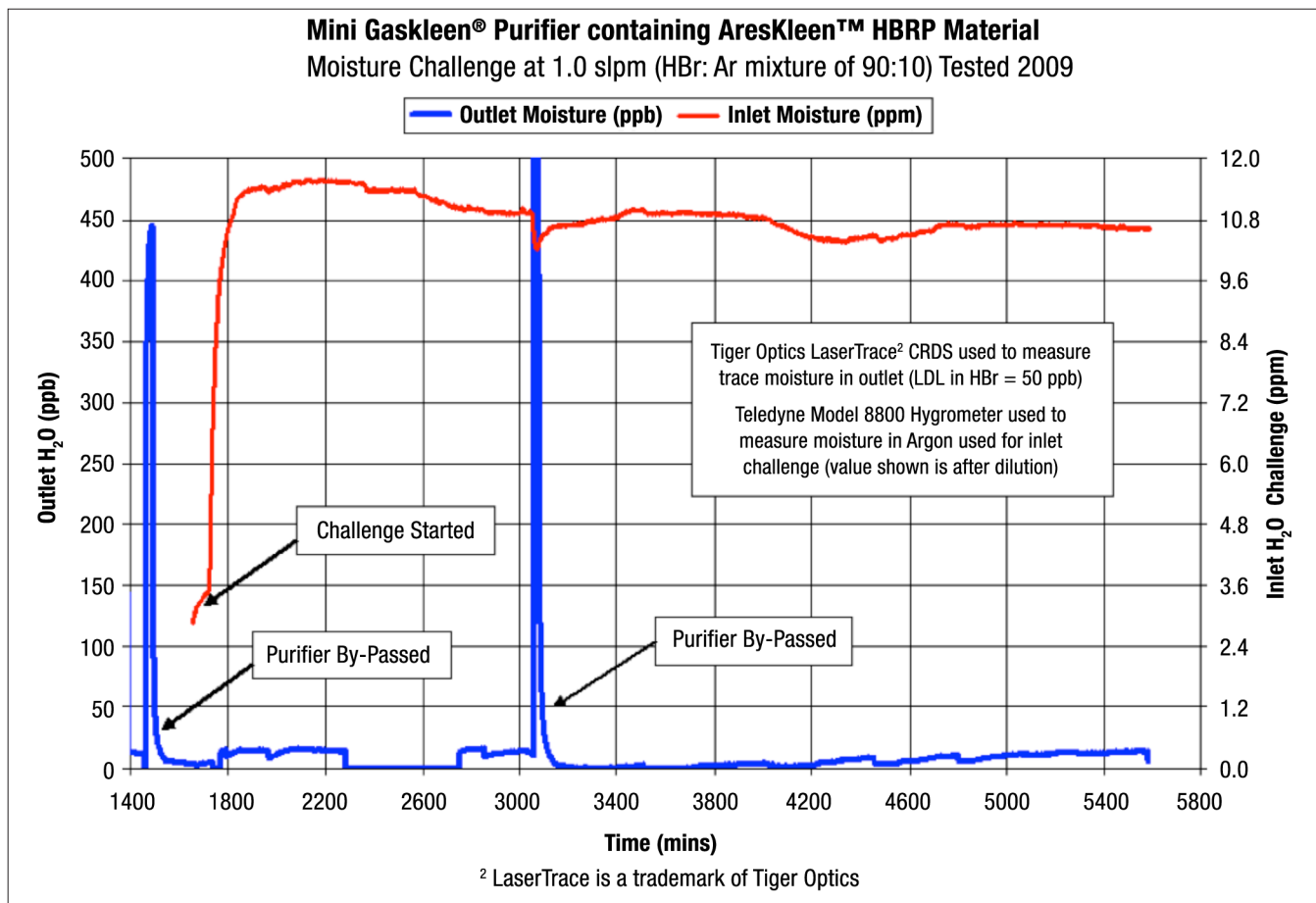

Figure 13. Removal of moisture using HBRP

phase composition was measured over time using FTIR. In the course of 4 hours, moisture significantly increased and HBr (as shown as negative peaks) decreased.

Moisture also participates during corrosion by forming metal bromide hydrates. The metal bromides formed in the corrosion reactions are hygroscopic. In the presence of moisture, they form metal bromide hydrates (for example,  $\text{FeBr}_3 \cdot 6\text{H}_2\text{O}$  and  $\text{FeBr}_2 \cdot \text{H}_2\text{O}$ ). This increases the volatility of the metallic compound; for example,  $\text{FeBr}_3$  has a melting/decomposition point of  $200^\circ\text{C}$ <sup>17</sup> whereas  $\text{FeBr}_3 \cdot 6\text{H}_2\text{O}$  has a melting point of  $27^\circ\text{C}$ <sup>18</sup>. Thus, again, moisture promotes the loss of material from the gas delivery system.

The effect of moisture on particle formation is shown in Figure 12<sup>15</sup>. In this study, HBr flow was cycled on and off through spool pieces. The spool pieces were constructed from 34 inch long  $\frac{1}{4}$ "-diameter tubing and built of stainless steel or Hastalloy (Hastalloy is a trademark of Haynes International, Inc.) Different moisture concentrations and tem-

peratures were used. For the 10 ppm moisture tests, particles formation increased over time (number of cycles).

### Use of HBr Purification in Plasma Etch

As discussed above, the presence of moisture in HBr can lead to particles, volatile metal bromides, and loss of material of the gas delivery system. The industry has learned that these effects can be minimized by removing moisture from the HBr.

As shown above, if moisture is kept below approximately 0.5 ppm, then HBr will not significantly corrode 316L. Thus, the main goal of HBr purification is to keep  $\text{H}_2\text{O}$  below at least 0.5 ppm. Purification can reduce the  $\text{H}_2\text{O}$  coming in with the HBr as well as the  $\text{H}_2\text{O}$  generated in the delivery system from HBr reacting with metal oxides.

Additionally, as HBr is consumed, moisture will concentrate in the liquid phase in the gas cylinder. Over the lifetime of the cylinder, the moisture concentration will increase, becoming

extremely high towards the end. To avoid this, a heel of 10 to 20% is typically left in the cylinder and returned to the supplier. Purification can allow for a smaller heel to be left and a greater portion of the HBr to be used.

Significant moisture can also enter the gas delivery system if there is too high of a flow rate out of the HBr cylinder and liquid droplets containing high moisture are entrained in the gas flow. Atmospheric moisture contamination can enter the system during cylinder change-outs and other line breaks in the gas delivery system. Purification offers protection for such process upsets. For all grades of HBr available (see Table 2 above), in order to keep moisture below 0.5 ppm, purification is required.

### HBRP Purification Material

Pall Corporation's HBRP purification material moisture removal claims are  $< 50$  ppb  $\text{H}_2\text{O}$  in HBr and  $< 1$  ppb  $\text{H}_2\text{O}$  in Ar<sup>23</sup>. The actual  $\text{H}_2\text{O}$  removal in HBr is likely below 50 ppb. The  $< 50$  ppb claim is limited by the ability to analyze for  $\text{H}_2\text{O}$  in HBr. Figure 13 shows

the removal of moisture from HBr gas using HBRP material<sup>24</sup>. Testing was conducted by Pall SL5.

The Pall HBRP material has also been shown to not contribute metals to the gas stream during purification. In these experiments, HBr gas was hydrolyzed into DI water and Inductively Coupled Plasma Mass Spectrometry (ICP-MS) was used to analyze resulting solutions. The data are summarized in Table 5<sup>25</sup>.

**Pall Corporation recommends the following point-of-use products:**

GLPHBRPVMM4 for flow rates up to 1 slpm:

<http://www.pall.com/pdfs/Microelectronics/A79.pdf>

GLP2HBRPVMM4 for flow rates up to 3 slpm or longer lifetimes at the lower flow rates:

[http://www.pall.com/pdfs/Microelectronics/A88\\_Gaskleen\\_II\\_Purifier.pdf](http://www.pall.com/pdfs/Microelectronics/A88_Gaskleen_II_Purifier.pdf)

Larger purifiers are also available for higher flow applications.

## Conclusion

HBr is used extensively in polysilicon etching. Moisture in the HBr can lead to several process concerns including metal contamination on the wafer and corrosion of the gas delivery system. These problems can be avoided by using Pall Corporation's HBRP material to purify the HBr within the fab.



## References

- Hynix Semiconductor, An Introduction of Etch Process [Online], Available: [http://palgong.knu.ac.kr/~necst/upload/pds\\_67\\_eight.pdf](http://palgong.knu.ac.kr/~necst/upload/pds_67_eight.pdf).
- "Etching" in Semiconductor Processing Overview, The Texas Engineering Extension Service, The Texas A&M University System, Bryan, TX, 1996, pp. 139-156.
- S.M. Sze. Semiconductor Devices—Physics and Technology, 2nd ed., John Wiley & Sons, (2002) p. 440. Available: [http://www.cleanroom.byu.edu/rie\\_etching.phtml](http://www.cleanroom.byu.edu/rie_etching.phtml).
- Semiconductor Services, Inc., San Jose University, Continuing Education—Wet and Plasma Etching [Online], Available: <http://www.engr.sjsu.edu/sgleixner/mate129/Continuing%20Ed/Etching/Etching.pdf>.
- M. A. Vyvoda et al. "Effects of plasma conditions on the shapes of features etched in Cl<sub>2</sub> and HBr plasmas. I. Bulk crystalline silicon etching," J. Vac. Sci. Technol., A 16 (6), (Nov/Dec 1998) pp. 3347-3258.
- V. Calderon, email to M. Wagner, May 15, 2012.
- W-H. Lo and W-C. Wang, "HBr Silicon Etching Process," U.S. Patent 6,358,859 B1, (March 19, 2002).
- Hydrogen Bromide 4.5 [Specification sheet], Praxair, document EG 48-4.5 08/2003.
- Hydrogen Bromide [Specification sheet], Air Liquide America Specialty Gases.
- "Hydrogen Bromide" in Semiconductor Products Catalog, Matheson Tri-Gas, V 4.0/SpecRev 4.51, pp. 40.
- Linde, Specialty Gases [Online], pp 30, Available: [linde-gase.de/download/Spec.Gases.e.02.02.pdf](http://linde-gase.de/download/Spec.Gases.e.02.02.pdf).
- Air Products, Process Chemicals—helping you from trials through to full-scale processing [Online], Available: [http://www.airproducts.co.uk/speciality\\_gases/products/process-chemicals.htm](http://www.airproducts.co.uk/speciality_gases/products/process-chemicals.htm).
- S.M. Fine et al. "The Role of Moisture in the Corrosion of HBr Gas Distribution Systems," J. Electrochem. Soc., Vol. 142, No. 4, (April 1995) pp.1286-1292.
- P.M. Clarke et al., "The Effects of Corrosive Gases on Metal Surfaces," in Microcontamination 93 Conference and Exposition, San Jose, CA, (1993) conference proceedings, pp. 433-442.
- A. Glew et al. "Accelerated Life Testing of Gas System Performance and Reliability," SEMATECH, Technology Transfer 97043272A-TR, (May, 1997).
- G.H. Smudde et al., "Materials Selection for HBr Service," Corrosion Science, Vol. 37, No 2, (1995) pp. 1931-1946.
- Wikipedia, Iron (III) bromide [Online], Available <http://en.wikipedia.org/wiki/febr3>.
- Handbook of Chemistry and Physics, 66th ed., CRC Press, Boca Raton, FL, 1985, pp. B-103.
- Lenntech, Stainless Steel 316L Chemistry % by Weight [Online], Available: <http://www.lenntech.com/stainless-steel-316l.htm#ixzz1sP2Q10MT>.
- Azom.com, Stainless Steel - Grade 316L—Properties, Fabrication and Applications [Online], Available: <http://www.azom.com/article.aspx?ArticleID=2382#>.
- United Performance Metals, 316/316L Stainless Steel Sheet & Coil—Chemical [Online], Available: <http://www.upmet.com/products/stainless-steel/316316l/chemical>.
- W. Murphy and B. Gotlinsky. Pall Corporation, Selection of 316L Stainless Steel for High Purity Semiconductor Gas Filter Assemblies [Online], Available: <http://www.pall.com/main/Microelectronics/Literature-Library-Details.page?id=2650>.
- Mini Gaskleen® Gas Purifier [Data sheet], Pall Corporation, Data Sheet A79h. Jun 2011.
- 24, 25. Internal Pall Report

**MATTHEW L WAGNER, PH.D.** IS SENIOR STAFF SCIENTIST, SCIENTIFIC & LABORATORY SERVICES AT PALL CORPORATION. **ROB NINE** IS SENIOR MARKETING MANAGER AT PALL MICROELECTRONICS GROUP, PALL CORPORATION.

This article appeared in the July/August 2013 issue of *Gases & Instrumentation International*, Vol. 7, Issue 4. [www.gasesmag.com](http://www.gasesmag.com)