



Fluid Cleanliness Management



Fluid Cleanliness Management

For Industrial Manufacturing processes and Mobile Equipment, maintaining a specified level of fluid cleanliness is critical to the operation and reliability of the systems involved. Through Fluid Cleanliness Management we can help you achieve the process improvements and cost savings you desire with our unique capability to take responsibility for the cleanliness “inside the machine”, from sub-component supplier... to initial build... to time in service... to the time when the machine is retired from service.

Contents

■ Particulate Contamination Control	06
Equipment Life Expectancy Factors	06
Fluid Functions	06
Fluid Properties	06
Sources of Contamination	07
Contamination Measurement	07
Contamination Analysis Methods	08
Reporting Particulate Contamination Levels	10
Cleanliness Level Comparison	11
Particulate Induced Component Wear Modes	12
Dynamic (Operating) Clearances	13
Typical Dynamic Clearances	13
Abrasive Wear	14
Fatigue Wear	14
Erosive Wear	15
Silting/Stiction	15
Adhesive Wear	16
Wear in Components	16
Breaking the Chain Reaction of Wear	18
Impact of Particle Contamination on Mean Time Between Failures (MTBF).....	19
Impact of Filtration on Abrasive Wear in Hydraulic Pumps	19
Impact of Fluid Contamination on Valve Shifting Force	20
Impact of Fluid Contamination on Bearing Life	20
Impact of Wear Control on Component Life	21
Industry Fluid Cleanliness Recommendations	21
■ Filtration Fundamentals	22
High Performance Element Construction	22
Filtration Medium	23
Anti-Static Construction	24
Filter Element Support and Drainage	25
Laid-Over Pleat shape vs. Fan Pleat Shape	25
Coreless/Cageless Construction	26
Filter Performance Ratings	27
Filtration Ratio	27
Beta Ratio vs. Particle Size	28
Beta Ratio and Downstream Fluid Quality	28
Cyclic Stabilization Test	29
Filter Ratings	31
Filter Performance Comparison from CST	32
Filter Performance Parameters	32
Service Life vs. Dirt Holding Capacity	33
■ Water Contamination Control	35
Water Contamination in Oils	35
Water Measurement Methods	36
Principle of Water Sensors	36
PPM Measurement vs. % Saturation	37
Detrimental Impact of Water on Fluids - Thermo-oxidative Stability.....	37
Detrimental Impact of Water on Fluids - Additive Precipitation.....	38
Detrimental Impact of Water on Gear and Vane Pumps.....	38
Detrimental Impact of Water on Roller Bearings.....	39
Controlling Water Contamination	39
Principle of Vacuum Dehydration	40
Controlling Water Contamination	41
Performance Comparison between Technologies	41
Separation Technologies – Liquid/Liquid Coalescence.....	42

■ Air Contamination Control	44
Air Contamination in Oils	44
■ Controlling Electrostatic Discharge	45
Triboelectric Charging and Electrostatic Discharge	45
Why are Today's Lube Oil Systems More Prone to ESD?	46
Measuring Triboelectric Charging	46
Anti-Static Filters	47
■ Controlling Varnish	48
What is Varnish?	48
Varnish Formation Mechanisms	48
Varnish Identification	49
Varnish Control Methods	50
■ Fluid Cleanliness Management	52
Determining Required Fluid Cleanliness Levels	52
Lube and Hydraulic Filter Locations	54
Lube and Hydraulic Filter Sizing	55
Importance of System Flushing	55
Fluid Sampling Methods	56
Importance of Fluid Filterability on Filter Service Life	58
Pall - Bensch Filterability Test	60
Importance of Differential Pressure Indicators and Switches	61
Mechanical and Electrical Differential Pressure Indicators	62
ISO Cleanliness and Filtration Standards	63
■ Component Cleanliness Assessment	64
Why do Components Need to be Clean?	64
Measure to Control	64
Component Cleanliness Measurement Standards	65
Component Cleanliness Management	67
■ Process Fluid Contamination Control	68
Typical Process Applications (In-plant)	68
Example of Typical Process Application: Parts-Washing	70
Typical Analyses Performed on Water Based Fluids	71
Typical Treatment Technologies	71
Depth Filter Configurations	73
Disposable Filter Elements	73
Depth Filter Elements	75
Filter Performance Test (modified OSU-F2 test)	75
Media and Structure	76
Surface Area and Dirt Capacity	77
■ Products	78
Pall Athalon™ Filters for Hydraulic and Lube Oils	79
Pall Supralon™ Replacement Filter Elements.....	80
Pall Diagnostic and Monitoring Equipment	81
Pall Reservoir Air Filters	81
Pall Fluid Conditioning Purifiers	82
Pall Melt Blown Filter Cartridges	83
Varnish Removal Filtration Unit	84
Energy Transition – The Road to Net Zero.....	85
Pall Filtration Solutions for Wind Turbines.....	85
Pall Rental and Services.....	86

Equipment Life Expectancy Factors

It has been estimated that 70 % of component replacement is due to surface degradation, or wear. In hydraulic and lubricating systems, 50 % of these replacements result from mechanical wear with another 20 % resulting from corrosion.

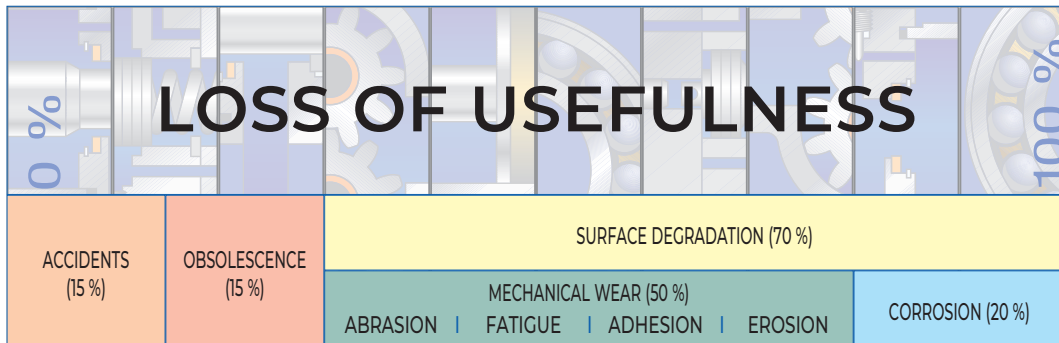

Presented at the American Society of Lubrication Engineers, Bearing Workshop.

Fluid Functions

- Lubrication/load-carrying
- Heat transfer
- Power transmission
- Suspends/transport contaminants
- Reduces component wear

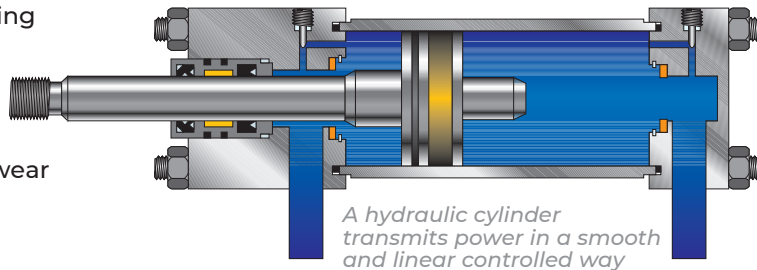

Fluid Properties that Impact Fluid System Performance

- Kinematic viscosity
- Density
- Compressibility
- Thermal/chemical stability
- Heat capacity and thermal conductivity
- Electrical conductivity

Sources of Contamination

Built-in Contaminants (manufacturing and assembly):

- Casting and machining debris (silica, metallic)
- Hose debris (rubber, metallic)
- Polishing compounds (alumina)
- Fibrous and other materials
- Fluid contamination

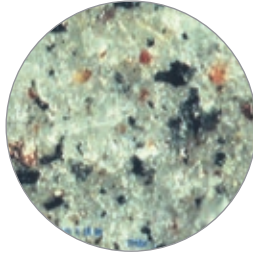

Break-in Wear Debris:

- Metallic
- Seal materials

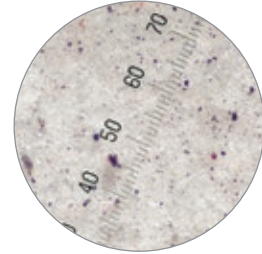

Service Operations:

- External ingress
 - Mineral contaminants (dirt/dust)
 - Water
- Internal generation
 - Component wear (metallic, seal material)
 - Fluid degradation products (thermal breakdown products, additive precipitation, etc.)

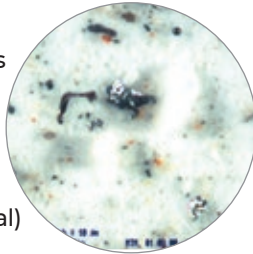

Contaminants Introduced During Maintenance:

- Built-in contamination
- Break-in wear debris
- External ingress

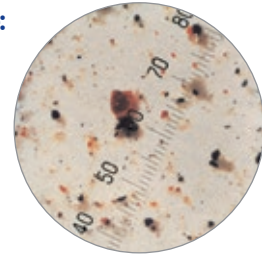

Contamination Measurement

The Micrometer “ μm ”

The micrometer is the standard for measuring particulate size in lubricating and fluid power systems.

“Micron” = micrometer = μm
 1 micron = 0.001 mm (0.000039 inch)
 10 micron = 0.01 mm (0.0004 inch)

Smallest dot you can see with the unaided eye $\sim 40 \mu\text{m}$
 Thickness of a sheet of looseleaf note paper $\sim 75 \mu\text{m}$
 Thickness of a human hair $\sim 75 \mu\text{m}$

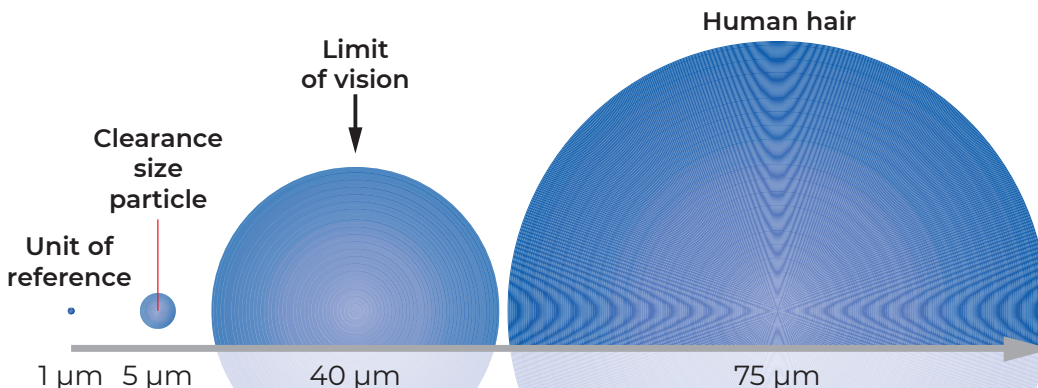

“You cannot manage what you do not measure”

Contamination Analysis Methods

Method	Units	Operation	Benefits	Limitations
Optical Particle Count Hybrid (particulate or coalescer)	Number per mL, Cleanliness code	Off-line; Laboratory	Provides size distribution; unaffected by fluid opacity, water, or air in fluid sample	Sample preparation and analysis time; requires specialized training
Automatic Particle Count	Number per mL, Cleanliness code	Off-line; "Sip" from containers; On-line	Fast and repeatable	Sensitive to "silts", fluid opacity, water, air, gels, and emulsions
Mesh Blockage	Cleanliness code	Off-line; "Sip" from containers; On-line	Not affected by fluid opacity, free water or air in fluid sample	Only two particle size ranges
High-resolution Image Processing Camera Sensor	Number/ ml Cleanliness code	On-line	Can recognise air bubble and count separately Not sensitive to varnish and silts. Not affected by low levels of free water just above saturation	Sensitive to high levels of free water
Patch Test and Fluid Contamination Comparator	Visual comparison, Cleanliness code	Off-line; Point of use	Rapid evaluation of system fluid cleanliness levels in field; helps to identify types of contaminants	Provides approximate fluid cleanliness levels
Ferrography	Scaled number of large/small ferrous particles	Off-line; Laboratory	Provides basic information on ferrous and magnetic particles	Very low detection of non-ferrous particles (e.g., brass, silica)
Spectrometry	PPM	Off-line; Laboratory	Identifies and quantifies inorganic chemical elements	Limited detection above 5 µm particle size
Gravimetric	mg/L	Off-line; Laboratory	Indicates total mass of contaminant	Cannot distinguish particle size; not suitable for moderate to clean fluids (e.g., cleanliness levels below ISO code 18/16/13)

Automatic Particle Counters (APCs)

Automatic particle counters are the most common method used by industry for particulate contamination analysis.

- APCs size and record the passage of individual particles in the fluid stream as they interrupt light from a laser to a photo detector. As a particle passes through the light beam, the light intensity received by the photo

detector is reduced in proportion to the size of the particle. The output of the detector is fed to a microprocessor to interpret the size and number of particles in the fluid.

- APCs are easy to use and provide accurate, repeatable results in both particle counts (number per mL) and cleanliness code.

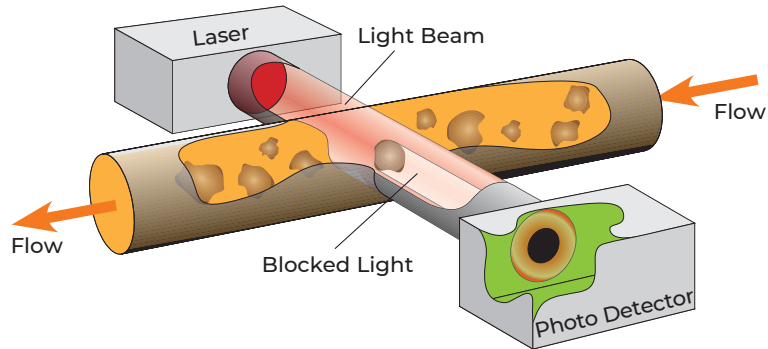

Mesh Blockage Devices

Mesh blockage devices are an alternative to APCs, especially in conditions where the fluid is opaque or where free water or air is present in the fluid.

Mesh blockage devices determine particulate contamination levels by passing a specified flow of sample fluid through

a series of calibrated mesh screens in a specified sequence. Pressure drop build-up (or flow degradation), which is dependent on particulate contamination levels, is measured and converted via algorithms to an ISO cleanliness code.

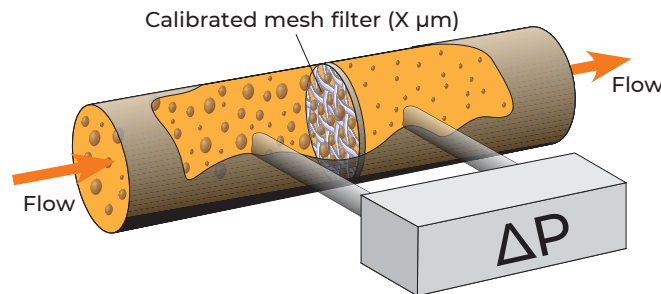

High-Resolution Image Processing Camera Sensors

These sensors acquire and automatically process the high-resolution images of a fluid and detect, quantify and classify solid particles by size and/or shape in real time. This technology is capable of distinguishing particles from air bubbles.

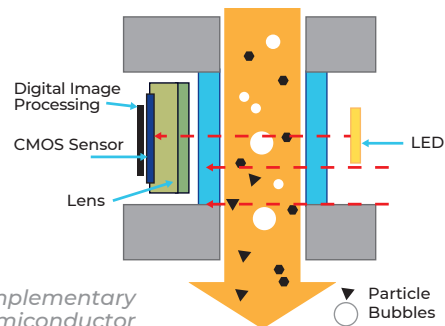

CMOS: Complementary Metal-Oxide Semiconductor

Reporting Particulate Contamination Levels

Cleanliness coding methods were developed to simplify the communication of particle count data at different particle sizes where the numbers can range from a single particle in clean systems to millions in dirty systems.

ISO 4406 – 1999

ISO 4406 reports fluid cleanliness using three code numbers corresponding to concentrations of particles greater than 4 μm(c), 6 μm(c), and 14 μm(c) in one mL of fluid. The results of particle counting are plotted on a graph. The corresponding Range Code, shown on the right of the graph, gives the cleanliness code number for each of three particle sizes.

For this example, the ISO Cleanliness Code is 16/14/12.

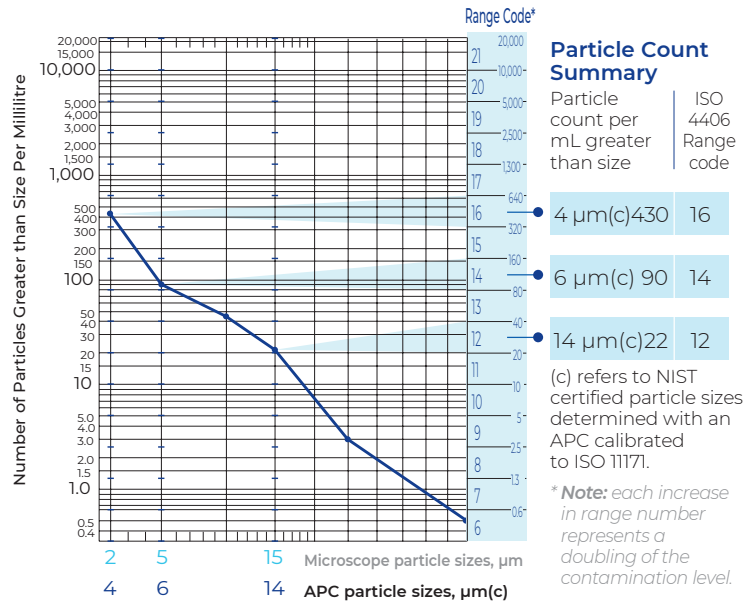

NAS 1638 and SAE AS4059F

NAS1638 was developed to qualify contamination levels in aircraft components. NAS1638 has been replaced by AS4059 and issue F has been adapted to provide contamination level data in both cumulative and differential sizes.

AS4059F, Table 1 Cleanliness Classes for Differential Particle Counts (Particles/100 mL)

Size, ISO 4402 Calibration, or Optical Microscope Count	5-15	15-25	25-50	50-100	> 100
μm	μm	μm	μm	μm	μm
Size, ISO 11171 Calibration or Electron Microscope	6-14	14-21	21-38	38-70	> 70
μm(c)	μm(c)	μm(c)	μm(c)	μm(c)	μm(c)
Cleanliness Class	00	0	1	2	3
	4	5	6	7	8
	9	10	11	12	

AS4059F, Table 2 Cleanliness Classes for Cumulative Particle Counts (particles/100 mL)

Size, ISO 4402 Calibration, or Optical Microscope Count	> 1	> 5	> 15	> 25	> 50	> 100
μm	μm	μm	μm	μm	μm	μm
Size, ISO 11171 Calibration or Electron Microscope	> 4	> 6	> 14	> 21	> 38	> 70
μm(c)	μm(c)	μm(c)	μm(c)	μm(c)	μm(c)	μm(c)
Size Code	A	B	C	D	E	F
Cleanliness Class	000	00	0	1	2	3
	4	5	6	7	8	9
	10	11	12			

AS4059 Class 6 in example above = ISO 4406 17/15/12

Same particle counts as for the ISO 4406 code shown hereabove
 Note: Table 1 is derived from NAS 1638
 ISO - International Organization for Standardization
 NIST - National Institute of Standards and Technology

AS4059 Code 6A/5B/6C/5D/5E in example above

NAS - National Aerospace Standards
 AS - Aerospace Standards

Cleanliness Level Comparison

Harmful wear particles can be effectively controlled only with high performance, wear control filtration.

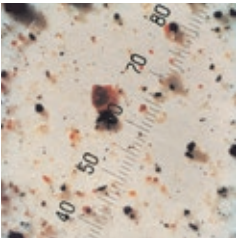
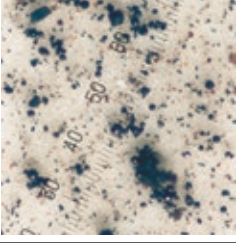
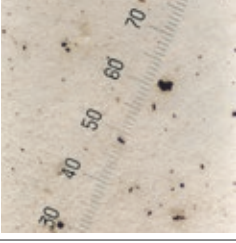
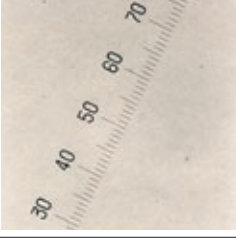
Photomicrograph (100X)	Description	Contaminants	Particle Counts per mL	ISO 4406 Codes and SAE AS4059F ^{1,2} Classes
	New oil from barrel	Silica Black metal Bright metal Plastics	> 4 μm(c) 12,345 > 6 μm(c) 3,280 > 14 μm(c) 450	21/19/16 (11A/11B/11C)
	New system with built-in contaminants	Bright metal Black metal Rust Silica Plastics	> 4 μm(c) 31,046 > 6 μm(c) 7,502 > 14 μm(c) 1,960	22/20/18 (12A/12B/12C)
	System with inadequate filtration	Bright metal Black metal Silica Plastics	> 4 μm(c) 7,504 > 6 μm(c) 1,150 > 14 μm(c) 160	20/17/14 (10A/9B/9C)
	System with $\beta_{5(c)} > 2,000$ wear control filtration	Some black metal	> 4 μm(c) 52 > 6 μm(c) 16 > 14 μm(c) 4	13/11/09 (3A/3B/4C)

¹AS4059 is based on 100 mL

²AS4059 classes are for the 3 ISO 4406 size ranges

Particulate Induced Component Wear Modes

Type	Primary Cause	Typical Affected Component(s)
Abrasive wear	Particles between adjacent moving surfaces	<ul style="list-style-type: none"> - Pumps (piston) - Journal bearings - Pistons (diesel engines) - Actuators and cylinders - Gears
Fatigue wear	Particle damaged surfaces subjected to repeated stress	<ul style="list-style-type: none"> - Roller bearings - Journal bearings - Gears
Erosive wear	High velocity particle impact	<ul style="list-style-type: none"> - Valves - Nozzles
Silting/Stiction	Build-up of particles in clearances	<ul style="list-style-type: none"> - Valves - Heat exchangers (silting) - Cylinders
Adhesive wear	Major asperity contact, fluid loss in clearances, reduced lubricity	<ul style="list-style-type: none"> - All
Corrosion (see Water Contamination section, p35)	Water/particulates interacting chemically with system components	<ul style="list-style-type: none"> - All
Cavitation (see Air Contamination section, p44)	Aeration of fluid	<ul style="list-style-type: none"> - Pumps - Cylinders - Valves

Each of these wear mechanisms result in the generation of particulate contamination capable of causing further component damage ("regenerative wear")

Dynamic (Operating) Clearances

Dynamic clearances are the separation between metal components under operating load, speed, temperatures and pressures. Knowledge of dynamic clearances is critical to understanding how particulate contamination impacts component wear.

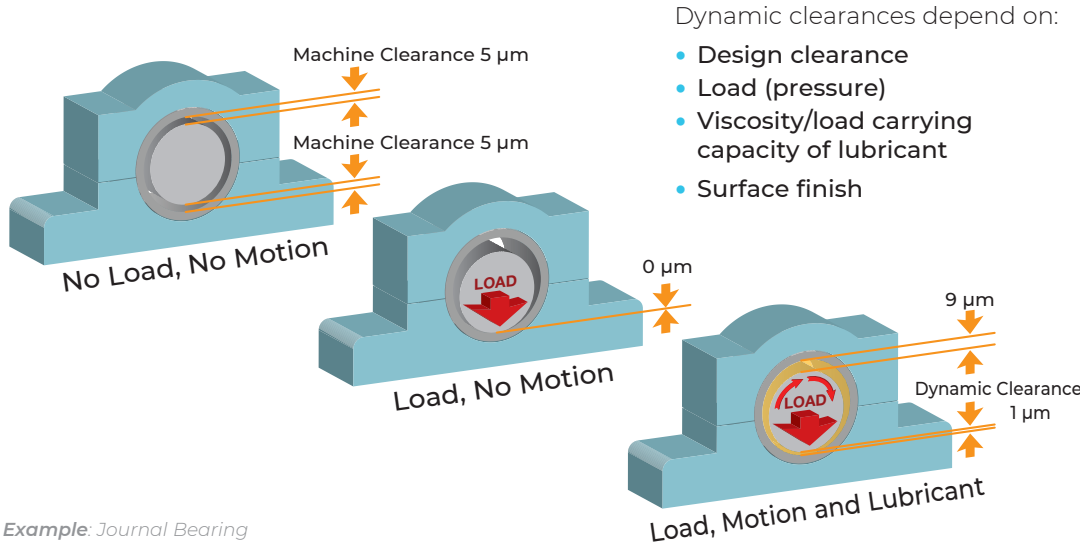

Example: Journal Bearing

Typical Dynamic Clearances

Component	Details	Clearances
Valves	Servo	1 - 4 µm
	Proportional	1 - 6 µm
	Directional	2 - 8 µm
Variable Volume Piston Pumps	Piston to Bore	5 - 40 µm
	Valve Plate to Cylinder block	0.5 - 5 µm
Vane Pumps	Tip to Case	0.5 - 1 µm
	Sides to Case	5 - 13 µm
Gear Pumps	Tooth Tip to Case	0.5 - 5 µm
	Tooth to Side Plate	0.5 - 5 µm
Ball Bearings	Film Thickness	0.1 - 0.7 µm
Roller Bearings	Film Thickness	0.1 - 1 µm
Journal Bearings	Film Thickness	0.5 - 100 µm
Seals	Seal and Shaft	0.05 - 0.5 µm
Gears	Mating Faces	0.1- 1 µm

Ref. ASME (American Society of Mechanical Engineers) Wear Handbook

Abrasive Wear

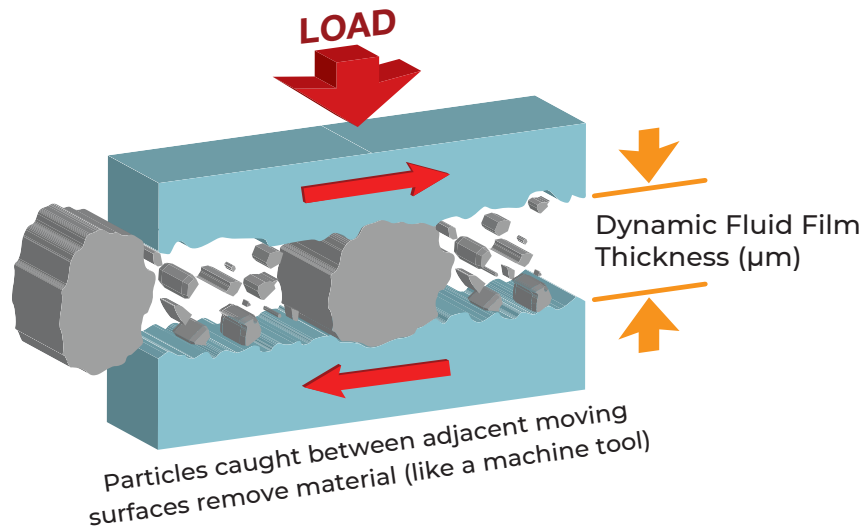

Abrasive Wear Effects

- Dimensional changes
- Leakage
- Lower pump efficiency
- Generated wear = more wear

Typical Components Subjected to Abrasive Wear

- | | |
|---|---|
| <ul style="list-style-type: none"> • All hydraulic components (pumps, motors, spool valves, and cylinders) | <ul style="list-style-type: none"> • Hydraulic motors • Journal bearings • Gears |
|---|---|

Fatigue Wear

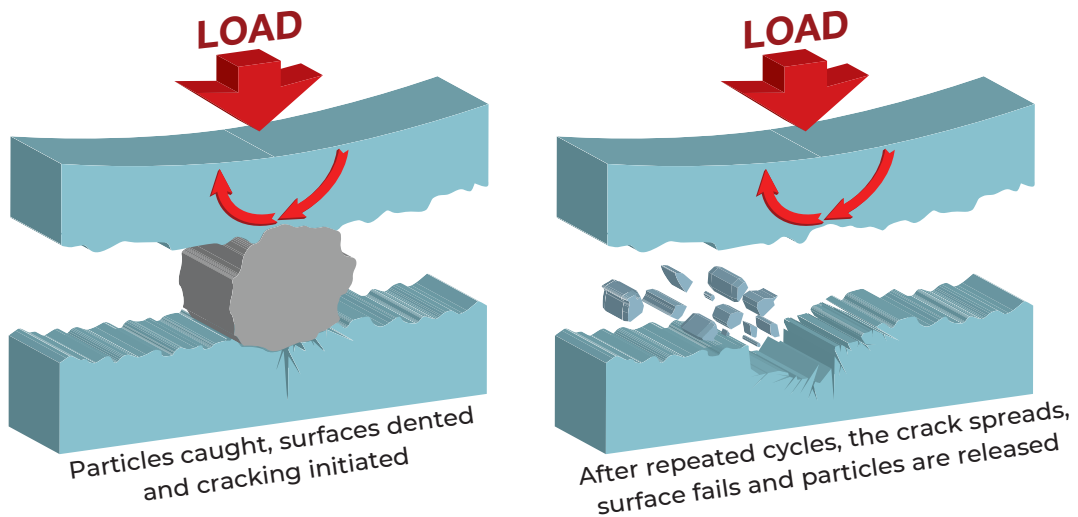

Fatigue Wear Effects

- Spalling failure of component
- Misalignment/vibration

Typical Components Subjected to Fatigue Wear

- | | |
|--|---|
| <ul style="list-style-type: none"> • Rolling element bearings • Journal bearings | <ul style="list-style-type: none"> • Hydrostatic bearings • Gears |
|--|---|

Erosive Wear

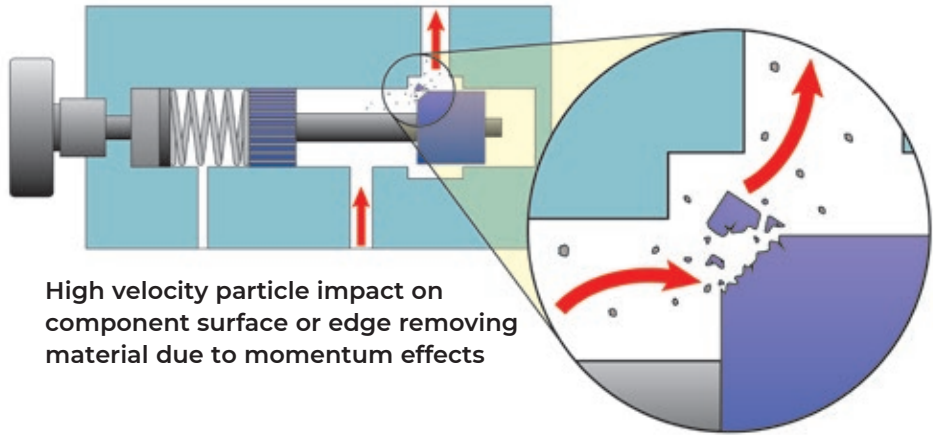

High velocity particle impact on component surface or edge removing material due to momentum effects

Erosive Wear Effects

- Dimensional changes
- Valve leakage
- Improper valve function
- Improper nozzle spray pattern

Typical Components Subjected to Erosive Wear

- Valves (servo, proportional, directional)
- Nozzles

Silting / Stiction

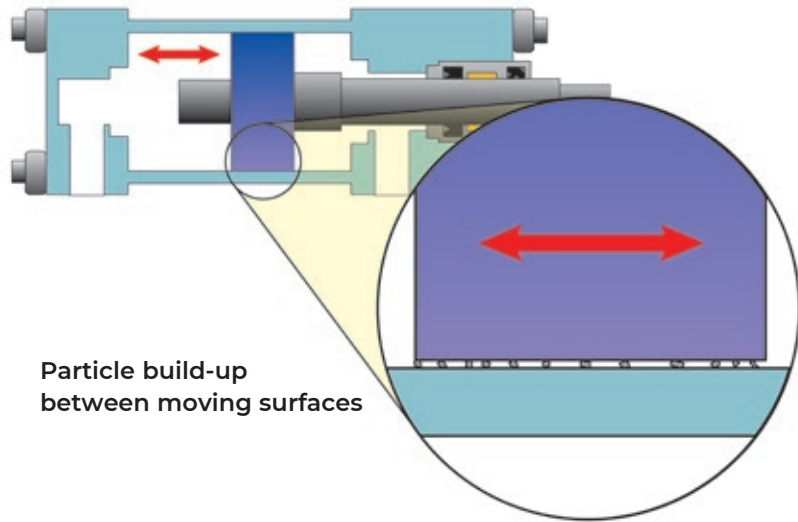

Particle build-up between moving surfaces

Silting/Stiction Effects

- Slow response, instability
- Spool jamming
- Solenoid burnout
- Impacts heat transfer characteristics (heat exchangers)

Typical Components Subjected to Silting/Stiction

- Servo valves
- Proportional valves
- Directional control valves
- Heat exchangers
- Cylinders

Adhesive Wear

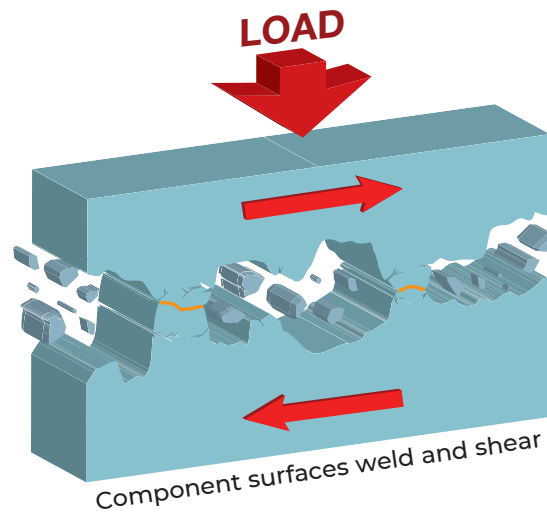

Adhesive Wear Effects

- Metal to metal points of contact
- “Cold welding” of surfaces
- Shearing of surfaces

Typical Components Subjected to Adhesive wear

- All moving components

Wear in Components

Pump Wear (abrasive wear)

Pumps are sensitive to particle contamination. Clearance size particles promote wear, resulting in greater leakage, higher temperatures, lower oil pump pressures and reduced efficiency.

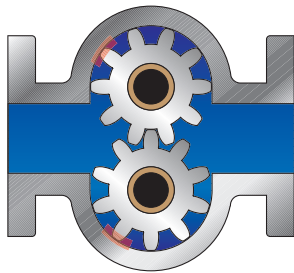

Gear Pump

Dynamic clearance

Tooth to side plate: 0.5 - 5 μm
Teeth tip to case: 0.5 - 5 μm

Relative particulate sensitivity: **MODERATE**

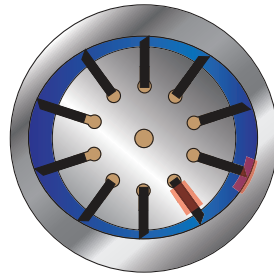

Vane Pump

Dynamic clearance

Vane sides: 5 - 13 μm
Vane tip: 0.5 - 1 μm

Relative particulate sensitivity: **MODERATE/HIGH**

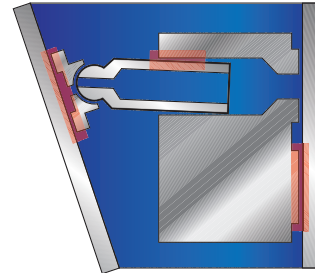

Piston Pump

Dynamic clearance

Piston to bore: 5 - 40 μm
Valve plate to cylinder: 0.5 - 5 μm

Relative particulate sensitivity: **HIGH**

Ref. ASME (American Society of Mechanical Engineers) Wear Handbook

Valve Wear (erosive wear, silting/stiction)

Valves are one of the most dirt sensitive components in a fluid system. Particulate contamination can cause slow, inaccurate response, leakage, and jamming.

Typical dynamic clearances

Servo valve	1 - 4 μm
Proportional valve	1 - 6 μm
Directional/control valve	2 - 8 μm

Relative particulate sensitivity: **HIGH**

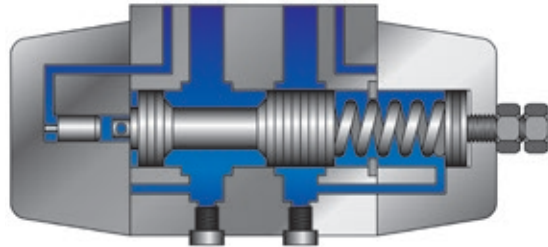

Cylinder Wear (abrasive wear)

Particulate contamination consequences

Rod seal wear:	Loss of oil through leakage / Contaminant ingress
Bronze bushing wear:	Loss of rod alignment
Piston seal wear:	Loss of cylinder speed / Loss of holding characteristics
Piston bearing wear:	Loss of alignment

Typical cylinder dynamic clearances

0.2 μm - 250 μm

Relative particulate sensitivity: **MODERATE**

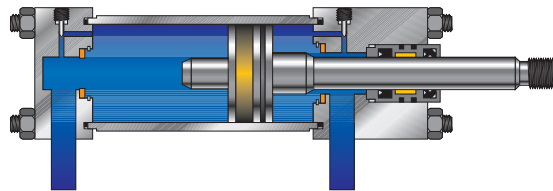

Bearing Wear (fatigue wear)

Contamination reduces bearing life significantly through fatigue and abrasive wear.

Typical dynamic clearances

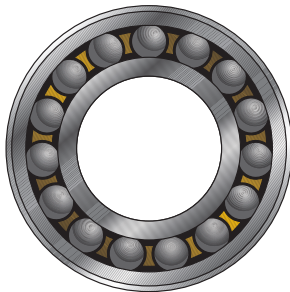

Rolling element bearings 0.1 - 1 μm

Relative particulate sensitivity: **HIGH**

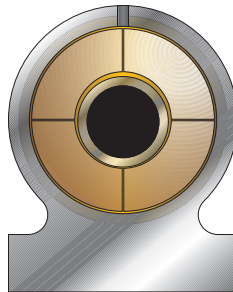

Journal bearings 0.5 - 100 μm

Relative particulate sensitivity: **MODERATE/HIGH**

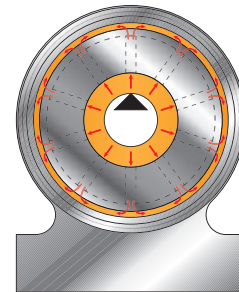

Hydrostatic bearings 1 - 25 μm

Relative particulate sensitivity: **MODERATE**

Breaking the Chain Reaction of Wear

When component clearances are bridged by metallic particles, (sand, dirt, and other wear debris), the chain reaction of wear begins. This happens when wear particles are left uncontrolled to build up and generate more particles within the system. High performance, wear control filters remove harmful particles for longer component life.

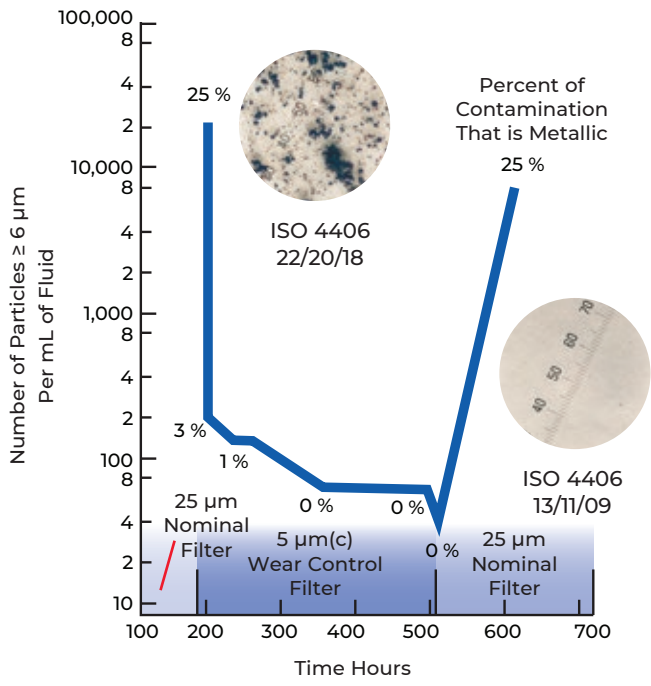
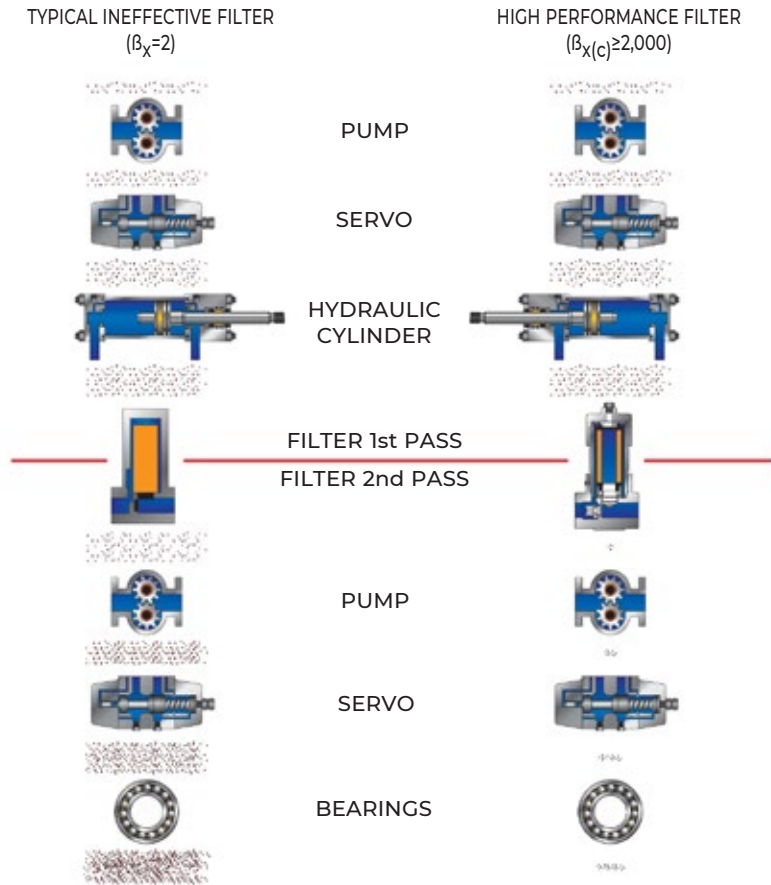

The system, fitted with inadequate filtration, stabilizes at a high contamination level with high metallic content (indicative of component wear). Replacing the existing filter with a high performance, wear control filter breaks the chain reaction of wear. This results in a rapid reduction of contaminant in the system and elimination of metallic content. Subsequent removal of the wear control filter and re-installation of the inadequate filter restarts the chain reaction of wear resulting in a rapid rise in contamination and metallic content.

Ref: SAE (Society of Automotive Engineers International) Technical Paper 690606

Impact of Particle Contamination on Mean Time Between Failures (MTBF)

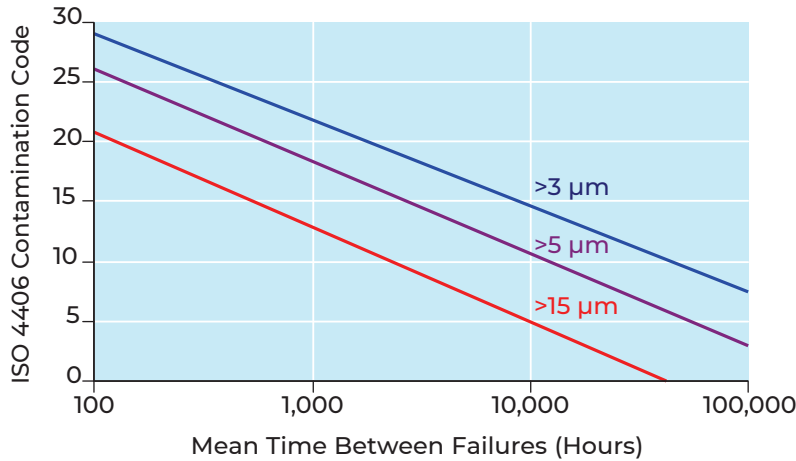

This study shows the relationship between dirt level and the resulting equipment reliability. It was estimated that over 60 % of the problems reported were traceable to the presence of particulate contaminant in the fluid.

Conclusion: "Particles of dirt in the oil is the single most important factor governing the life and reliability of hydraulic systems".

Source: United Kingdom Department of Trade and Industry Study

Impact of Filtration on Abrasive Wear in Hydraulic Pumps

This test on 3,000 psi (207 bar) piston pumps clearly shows the wear-reducing benefit of filtration. The report concludes that the dominant wear mechanism causing pump performance degradation was hard particle abrasive wear between sliding surfaces.

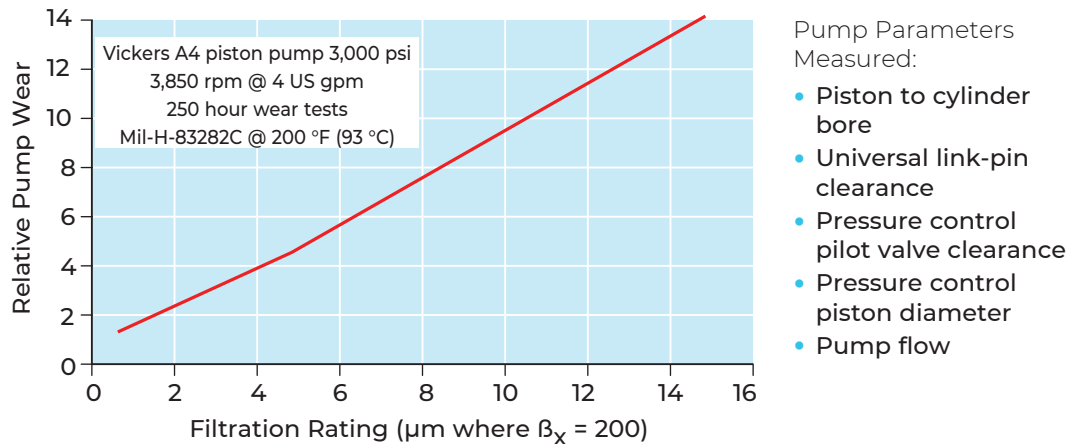

Presented at SAE A6 Meeting - J. Ohlson, NADC (National Aerospace Development Center)

Impact of Fluid Contamination on Valve Shifting Force

Conditions of Directional Valve

- Flow: ~15 US gpm (56.8 Lpm)
- Pressure: 3,000 psi (207 bar)
- Valve Radial Clearance: 8 μm
- Valve held stationary and under pressure before shifting force was measured

This study illustrates how valve silting/stiction from particle build-up between moving surfaces increases valve shifting force. Note how the highest force is required when the valve is challenged by particles in the dynamic clearance size range (~10 μm).

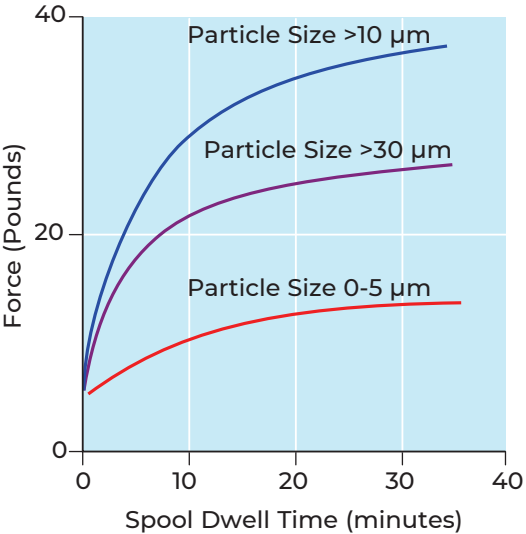

Reference: Oklahoma State University

Impact of Fluid Contamination on Bearing Life

The cleanliness of the lubricating fluid has a direct influence on the life expectancy of roller bearings. Based on lifetime trials, FAG has defined a formula giving the life expectancy for different types and sizes of roller bearings based on oil cleanliness levels.

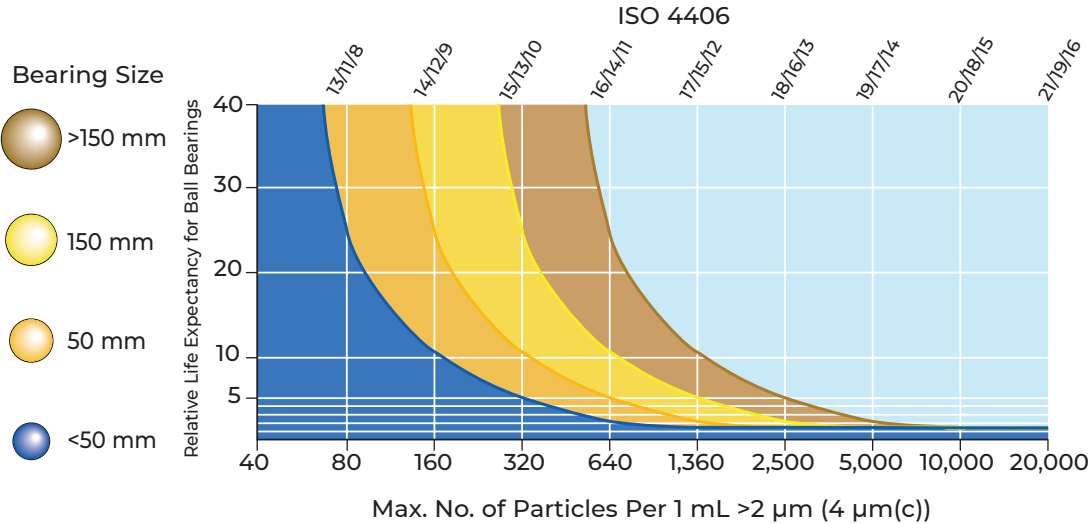

Co-authored by FAG-Pall, 'Economy and safety for rolling bearings can be calculated'

Impact of Wear Control on Component Life

To minimize wear and maximize component service life, clearance size particles must be removed from the system.

Component	Improvement
Pump/motor	4 to 10 x increase in pump and motor life
Hydrostatic transmission	4 to 10 x increase in hydrostatic transmission (HST) life
Valve	5 to 300 x increase in valve life
Valve spool	Elimination of valve stiction
Roller bearing	50x extension of roller bearing fatigue life
Journal bearing	10x extension of journal bearing life
Fluid	Extension of fluid service life and reduction of disposal costs through reduced contamination caused fluid degradation

Industry Fluid Cleanliness Recommendations

When designers of hydraulic and lubrication systems establish fluid cleanliness level limits for a specific system, they need to take into consideration all relevant system parameters such as:

- System operating pressure and duty cycle
- Operating environment
- Component sensitivity and life expectancy
- Economic liability and cost of downtime
- Safety environment

In the “Fluid Cleanliness Management” section (see page 40), a detailed worksheet enables you to define the Required Cleanliness Level for your application. Shown below are recommended Fluid Cleanliness Levels for typical hydraulic components.

Typical Industry Fluid Cleanliness Recommendations*

System Components	<140 bar (<2000 psi)	140-210 bar (2000-3000psi)	>210 bar (>3000 psi)
Servo Valves	16/14/11	15/13/11	14/12/10
Proportional Valves	17/15/12	16/14/12	15/13/11
Variable displacement Pumps	17/16/13	17/15/12	16/14/11
Fixed Piston Pumps	18/16/14	17/16/13	17/15/12
Pressure/Flow Control Valves	19/17/14	18/16/14	17/16/13
Gear Pumps	19/17/14	18/16/14	18/16/14

* Based on bottle sampling; cleanliness recommendations based on on-line particle monitoring would be significantly lower. On-line monitoring is strongly recommended for today's operating system conditions.

High Performance Filter Element Construction

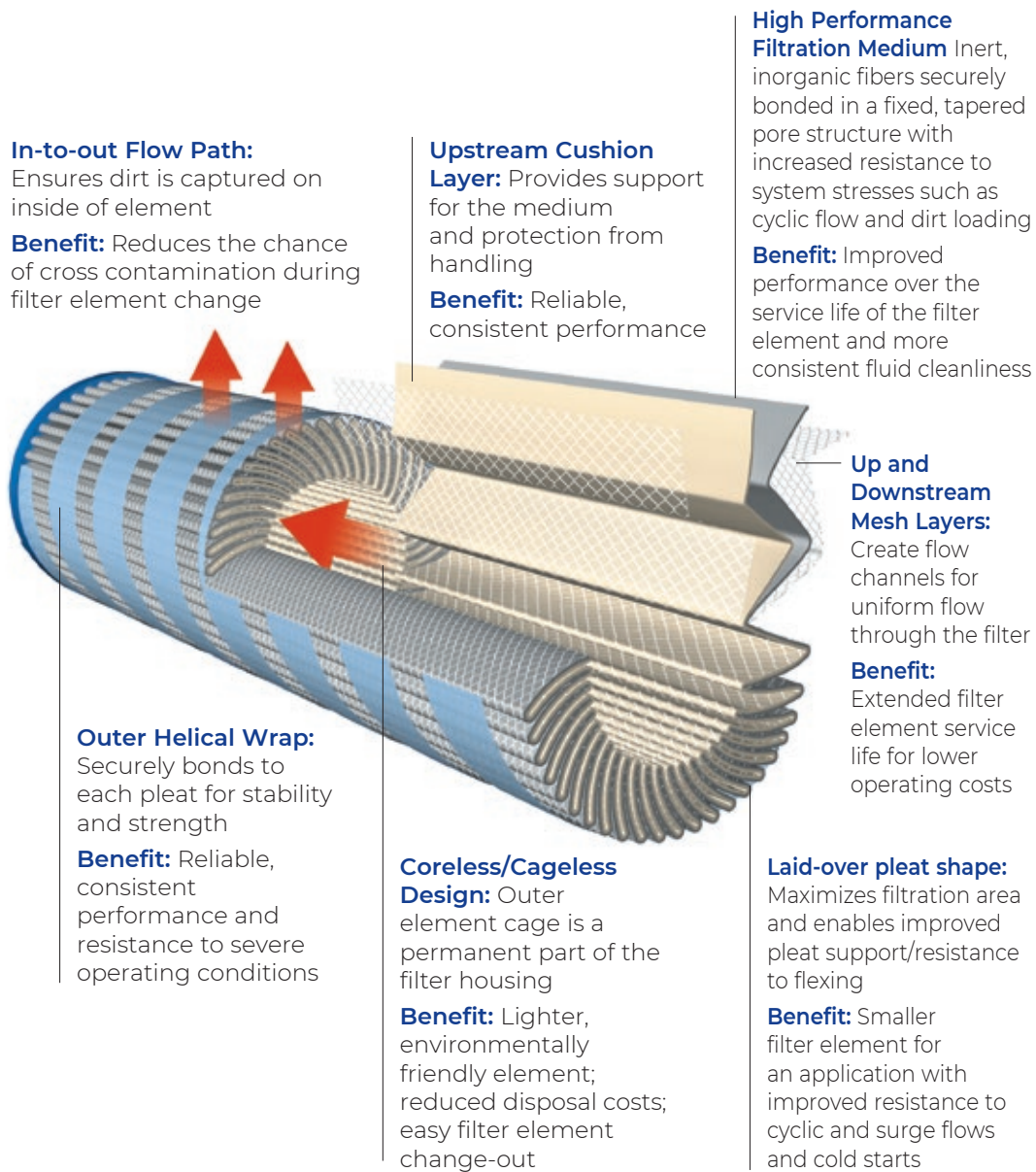

Medium Substrate Support Layer (not shown):

Provides support for the medium and aids in drainage flow

Benefit: Reliable, consistent performance

Anti-Static Design: Element pack composed of materials for minimized triboelectric charge generation and no electrostatic discharges

Benefit: No damage to filter element or housing or other system components from electrostatic discharge; minimizes fluid degradation

Filtration Medium

Importance of Fiber Size

Fiber size and fiber density govern the filter medium's pore size and porosity

Cellulose

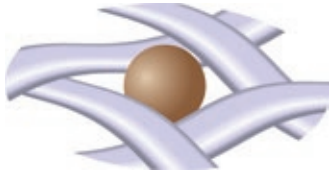

15 to 25 μm

Polymeric

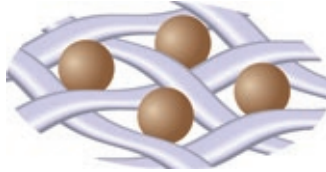

10 to 15 μm

Glass fiber

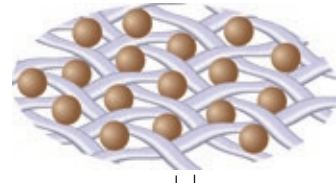

1 to 5 μm

Benefits of small fiber diameter:

- Higher dirt capacity
- Lower pressure drop
- Longer service life

Benefits of inert inorganic fibers:

- Wide chemical compatibility
- No swelling
- No shelf life limitations

Fixed Pore vs. Non-Fixed Pore Construction

In fixed pore media, fibers are bonded with specially formulated resin to resist deterioration from pressure, flow fluctuations, temperature and age.

Fibers in non-fixed pore media are inconsistently or poorly bonded. This facilitates movement of fibers under pressure and flow surges allowing particles to pass through the media (Channelling of unfiltered particles or unloading of captured particles). Fibers can also break loose and pass into the system causing additional contamination as well as unloading of particles.

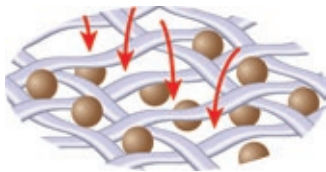

Channeling

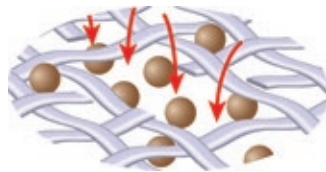

Unloading

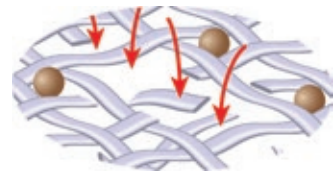

Medium Migration

Tapered Pore vs. Uniform Pore Structure

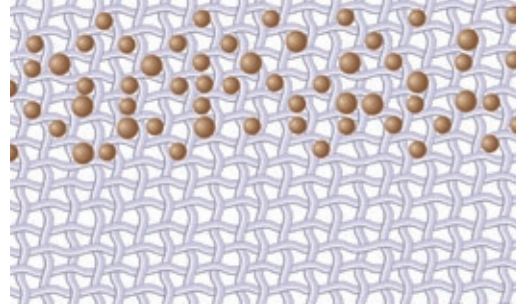
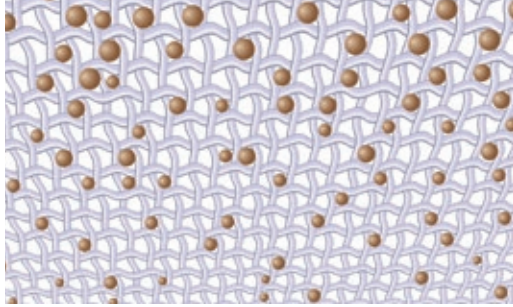

Tapered Pore Design

Tapered pore medium construction enables the coarser upstream surface to act as a pre-filter, capturing larger particles and allowing finer downstream pores to capture critical clearance-sized particles. This reduces operating costs by combining maximum particle retention with extended service life.

In addition, the use of small diameter fibers leaves more void volume to hold particles compared to conventional glass fiber media of similar pore size, but made with thicker fibers.

Uniform Pore Design

Uniform pore medium construction limits the effective use of the available void volume to capture particles, resulting in a reduction in the total number of particles captured and hence, filter service life.

Anti-Static Construction

Electrostatic charge can be generated by the flow of hydrocarbon fluids through porous media contained in a filter element. With low fluid electrical conductivity, this charge referred to as triboelectric charging can accumulate on the filter element and fluid. It can later discharge, causing noise and potential damage to the filter element, filter housing, or fluid.

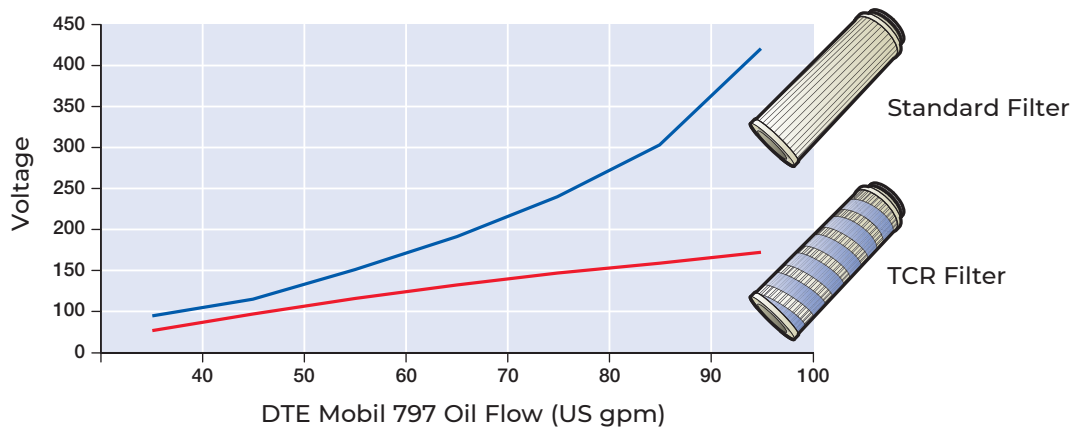

- Typical resin bonded glass fiber media are prone to triboelectric charging due to friction between fluid and glass fibers. Triboelectric charging can lead to:
 - Filter and fluid system component damage
 - Fluid degradation
- High performance triboelectric charging resistant media (TCR media):
 - Eliminate filter and other component damage
 - Minimize fluid degradation

Filter Element Support and Drainage

Unsupported Filter Element

This figure represents a poorly supported fan-pleat filter element subjected to high differential pressure or “cold start” flow conditions.

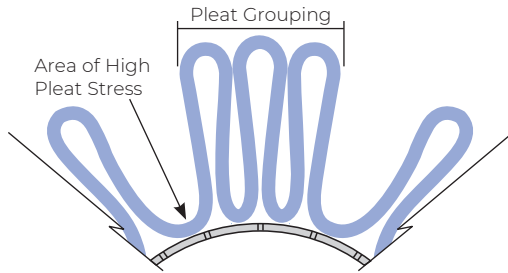

The pleats tend to be unstable and can move, thus increasing pressure on the flanks of the pleats. The result can be pleat collapse and the “bunching” together of pleats, which reduces useable filtration area, fluid drainage, and filter element service life.

Supported Filter Element

The filter in this figure contains a rugged support structure to resist damage from high differential pressure or cold start conditions.

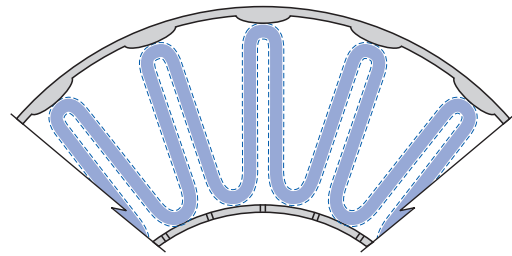

The pleats are supported on both the upstream and downstream sides, and are held in place by the helical wrap on the outside of the element. With uniform pleat spacing and drainage maintained, the element provides consistent performance and long service life.

Laid-Over Pleat Shape vs. Fan Pleat Shape

Filter Area

Traditional fan-pleat filter elements have their pleats radiate outward from the filter element core. The radially increasing space between the pleats creates unused volume (spaces without filter media).

Elements with laid-over pleat geometry have no unused spacing between the pleats and therefore no wasted volume. Laid-over pleat geometry maximizes the filtration area in a filter element.

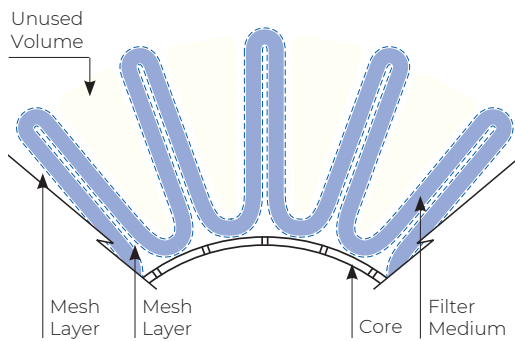

Fan-pleated filter element

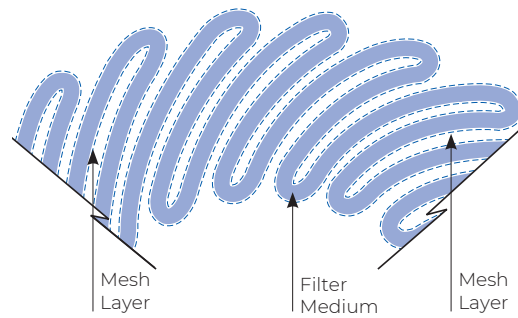
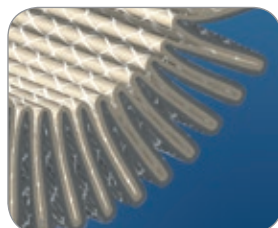

Laid-over pleat filter element

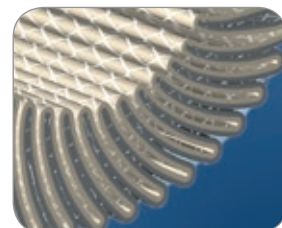

Flow Distribution

In traditional fan-pleat filter elements, fluid flow is less restricted in some parts and more restricted in others, resulting in uneven flow distribution and dirt loading within the filter element during operation.

Fluid passing through the tips of the pleats must travel along a more restricted flow path than the flow passing through the root of the pleats. This is illustrated by the different sized flow arrows in the left figure below.

Pleats in elements with laid-over pleats are designed to support each other along the entire length of the pleat. The flow resistance is the same, regardless of where along the pleat the flow passes through the medium. This creates a uniform flow velocity through the filter element (illustrated by the uniform size arrows in the right figure below) and, therefore, uniform flow distribution and dirt build-up within the filtration medium. The result is greater dirt holding capacity and longer filter element service life.

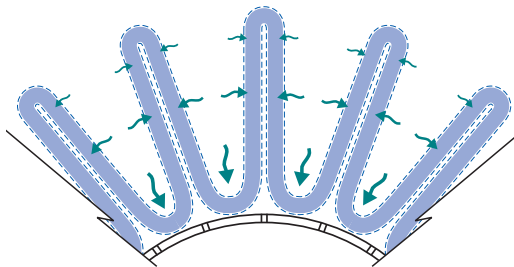

Fan-pleated filter element

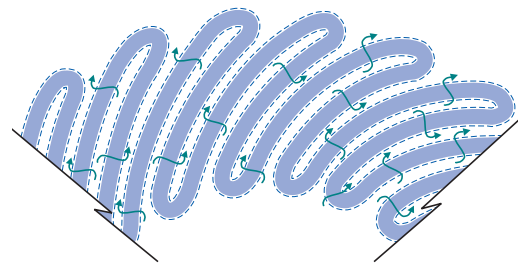

Laid-over pleat filter element

Coreless / Cageless Construction

With environmental regulations concerning the disposal of used oil and filters continuing to proliferate, many industries are searching for ways to minimize waste.

By incorporating the filter element core into the filter housing and using reinforced polymer hardware instead of metal, the structural integrity of the filter element pack can be maintained while making it more environmentally friendly.

Coreless filter elements:

- Reduce element weight by as much as 60 % compared to elements with integral metal cores
- Can be compressed to significantly reduce volume for disposal
- Can be incinerated adding BTU/calorific value in waste-to-energy operations

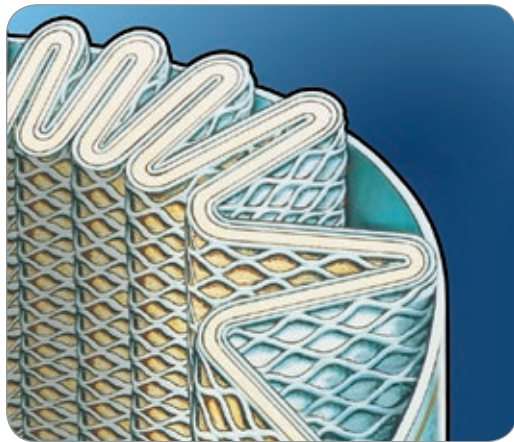

Coreless filter element

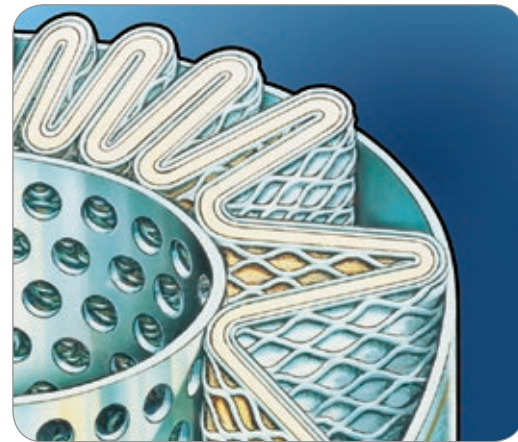

Element with integrated core

Filter Performance Ratings

Nominal Rating

An arbitrary micrometer value, based on weight percent removal, indicated by the filter manufacturer. Due to lack of reproducibility, this rating is rarely used.

Absolute Rating

The diameter of the largest hard spherical particle that will pass through a filter under specified test conditions. This is an indication of the largest opening in the filter element.

Filtration Ratio ($\beta_{x(c)}$)*

The ratio of the number of particles equal to and greater than a given size, $X(c)$, in the influent fluid to the number of particles equal to and greater than the same size, $X(c)$, in the effluent fluid.

ISO Code Rating (from Cyclic Stabilization Test, based on SAE ARP4205, see page 29)

The stabilized fluid cleanliness level achieved at 80 % of the net terminal pressure drop under cyclic flow (considered the worst operating condition)

*Note: (c) refers to NIST certified particle sizes, based on the determination of the particle size distribution of a reference lot of ISO Medium Test Dust.

Filtration Ratio (Beta Ratio)

The filtration ratio, or Beta ratio (β), is defined as the ratio of the particle concentration for a cumulative particle size range upstream of the filter element to the particle concentration for the same cumulative particle size range downstream of the filter element.

$$\text{Filtration ratio } \beta_{x(c)} = \frac{\text{Number of upstream particles } \times \mu\text{m}(c) \text{ and larger}}{\text{Number of downstream particles } \times \mu\text{m}(c) \text{ and larger}}$$

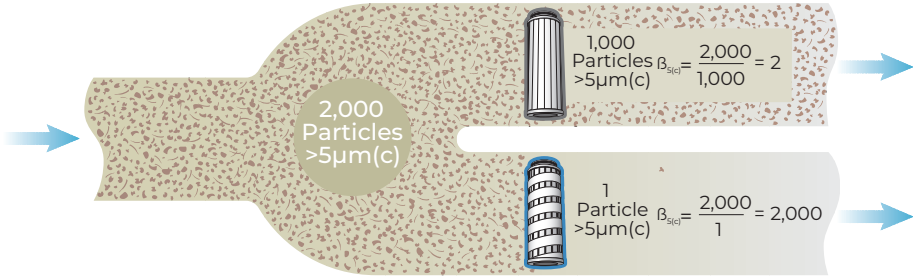

Multi-Pass Test (ISO 16889)

The Multi-pass test is an accelerated test that quantifies filter element performance in terms of filtration efficiencies (measured as filtration ratios) and dirt capacity under standardized test conditions.

The Multi-pass test is intended to simulate recirculating fluid systems.

Schematic

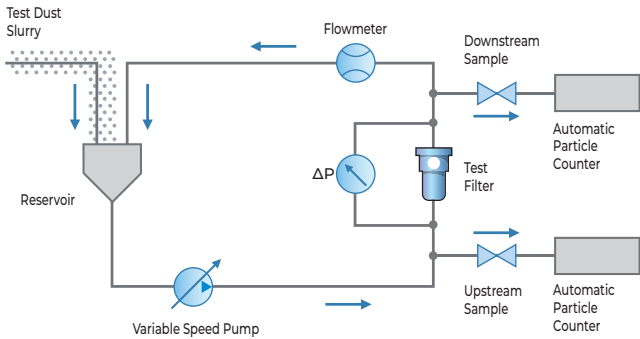

Beta Ratio vs. Particle Size

Typically, the average filtration ratios derived from the Multi-pass test are plotted against the corresponding particle sizes on a log-linear scale to depict the “filtration efficiency spectrum” of the filter element in graphical form. While the “efficiency spectrum” provides a comprehensive picture of the filtration performance of the filter element, it is customary and convenient to designate the filter element in terms of a “single point” filter rating. Beta = 2,000 ratings are designated in the figure below.

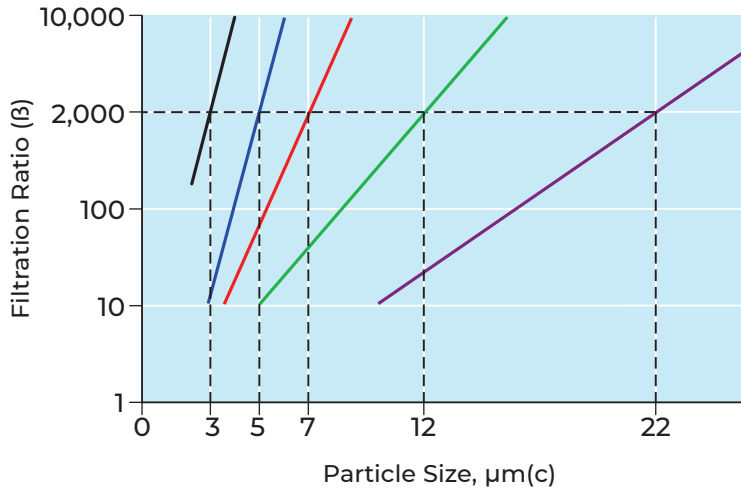

Beta Ratio and Downstream Fluid Quality

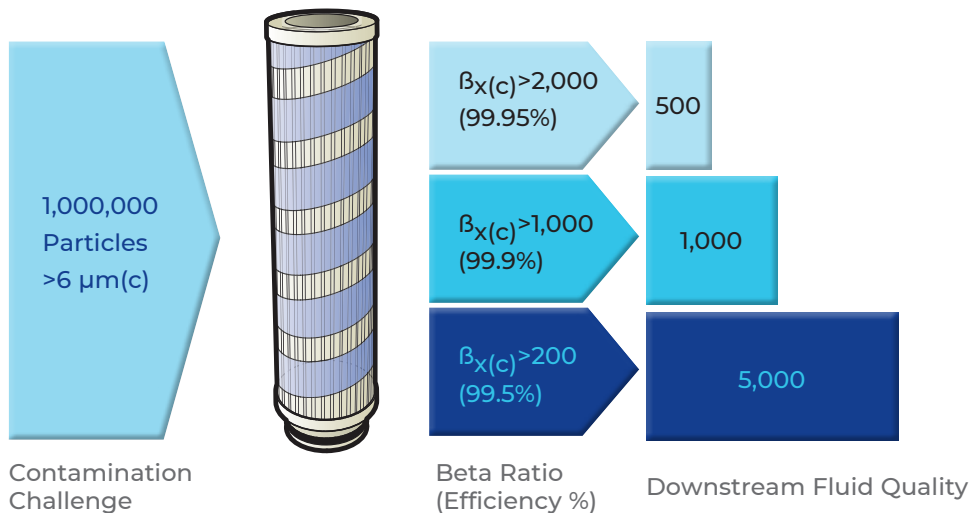

If a filter is challenged with 1,000,000 particles of a size $>5 \mu\text{m(c)}$, its Beta Ratio value will determine how many particles pass downstream. Fluid downstream of the $\beta_{x(c)} >2,000$ filter is 2 times cleaner than a $\beta_{x(c)} >1000$ filter and 10 times cleaner than a $\beta_{x(c)} >200$ filter.

Cyclic Stabilization Test (SAE ARP 4205)

The Cyclic Stabilization Test (CST) is a more recently introduced method that allows evaluation of the effects of cyclic flow and dirt loading on the performance of filters.

Limitations of the Multi-pass Test

- High test dust injection rate (1,000 to 10,000 times higher than in the field)
- Uses only steady state flow
- Does not include real-world conditions such as cyclic variations in flow and pressure, and low dirt loading rate
- Reports only average removal efficiency, which can overshadow performance degradation over the life of the filter

How the Test is Performed...

- Multi-pass test stand modified for cyclic flow (25 % to 100 % of rated flow)
- Filtration ratios are recorded under cyclic flow conditions
- Contaminant injection is stopped at 2 points (2.5 % and 80 % of net terminal pressure drop). Filter cleans up system to stabilized levels. Stabilized cleanliness levels are recorded

Schematic

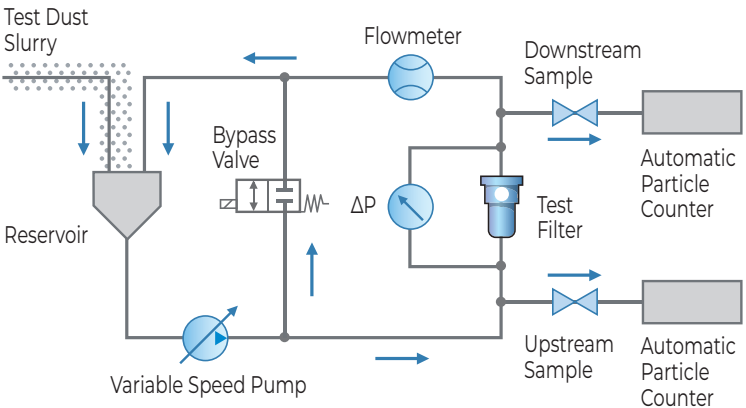

Advantages of the CST Method

- CST measures the fluid cleanliness achieved by the filter under cyclic flow conditions, which is more representative of hydraulic system operation
- CST measures fluid cleanliness maintained by the filter under very low contamination ingress levels, which is more representative of actual field conditions
- Fluid cleanliness is reported as an ISO 4406 code at 80 % of net terminal ΔP (worst operating condition)

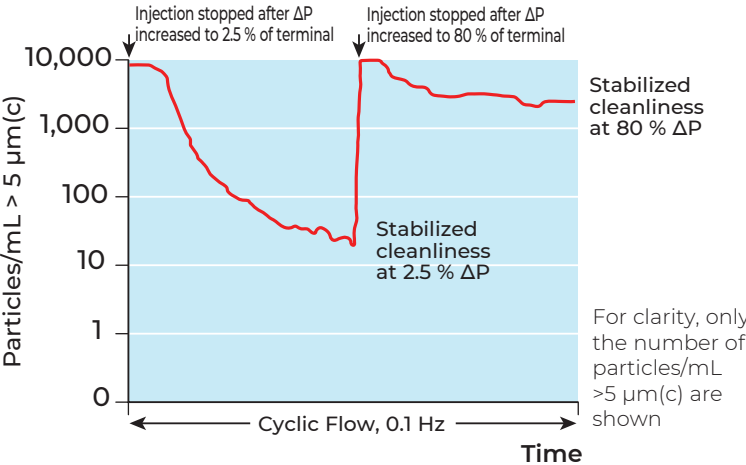

Filter Performance Comparison from CST

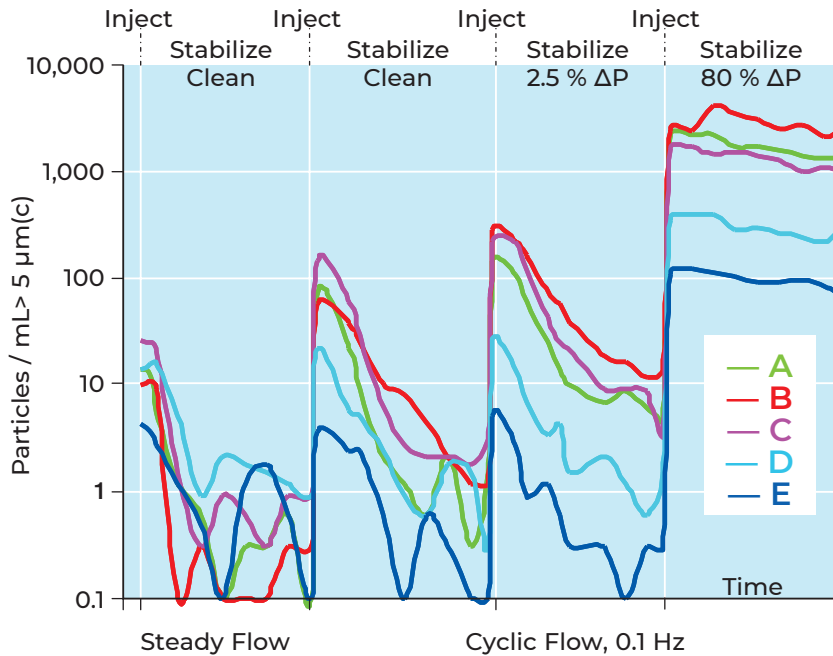

The graph above shows the downstream particle counts for 5 different filters. These tests demonstrate that although the filters provide good control of particles $>5 \mu\text{m(c)}$ when new or with steady flow, their ability to control particles changes substantially when they become loaded and are under cyclic conditions. For example, Filter “B”, one of the best performers under steady flow, exhibited the worst particle control under cyclic and loaded conditions.

CST Filter Performance Comparison

Filter	Stabilized Particle Count per mL at 80% net ΔP		
	$> 4 \mu\text{m (c)}$	$> 6 \mu\text{m (c)}$	$> 14 \mu\text{m (c)}$
A	4,200	540	20
B	7,200	970	47
C	3,400	420	18
D	1,100	70	0.8
E	380	31	0.4

Comparing filters with similar Beta ratings using the CST test reveals true performance differences:

- Filter A stabilizes the system with over 17 times more $6 \mu\text{m(c)}$ and larger particles than filter E
- Filter B stabilizes the system with over 31 times more $6 \mu\text{m(c)}$ and larger particles than filter E
- Filter C stabilizes the system with over 13 times more $6 \mu\text{m(c)}$ and larger particles than filter E
- Filter D stabilizes the system with over 2 times more $6 \mu\text{m(c)}$ and larger particles than filter E

CST Filter Performance Comparison

Shown at right are photomicrographs representing the performance of “similar” filters rated at 5 μm(c) per ISO 16889 tested via the Cyclic Stabilization Test.

Out of the three filter elements, filter 3 provides far superior particulate removal under CST conditions.

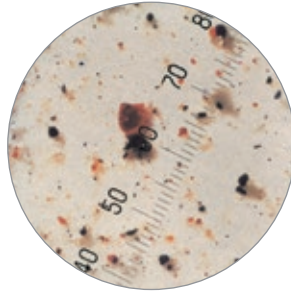

Filter 1

ISO 4406 Cleanliness Code **20/17/13**
Particle Count Summary

Size	Particle Count per mL	ISO 4406 Code
>4 μm(c)	7,200	20
>6 μm(c)	970	17
>14 μm(c)	47	13

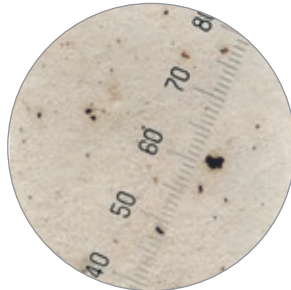

Filter 2

ISO 4406 Cleanliness Code **19/16/11**
Particle Count Summary

Size	Particle Count per mL	ISO 4406 Code
>4 μm(c)	4,200	19
>6 μm(c)	540	16
>14 μm(c)	20	11

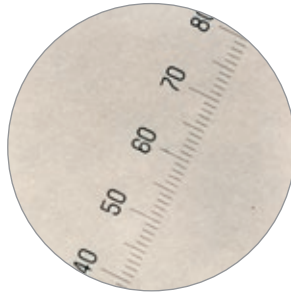

Filter 3 (Stress-Resistant Technology)

ISO 4406 Cleanliness Code **12/07/02**
Particle Count Summary

Size	Particle Count per mL	ISO 4406 Code
>4 μm(c)	25	12
>6 μm(c)	0.8	7
>14 μm(c)	0.02	2

Filter Ratings – High Performance Wear Control Filters

Code	$\beta_{x(c)} \geq 2,000$ per ISO 16889	CST Cleanliness Rating*
AZ	3	07/04/01
AP	5	11/08/03
AN	7	13/09/04
AS	12	15/11/06
AT	22	16/14/08

* Filter cleanliness rating from stabilized cleanliness levels at 80 % of net terminal ΔP based on SAE ARP4205

Note: CST Cleanliness Code ratings are laboratory measurements under standard conditions. Cleanliness measured in actual operation will depend on operating conditions and sampling method.

Filter Performance Comparison from CST

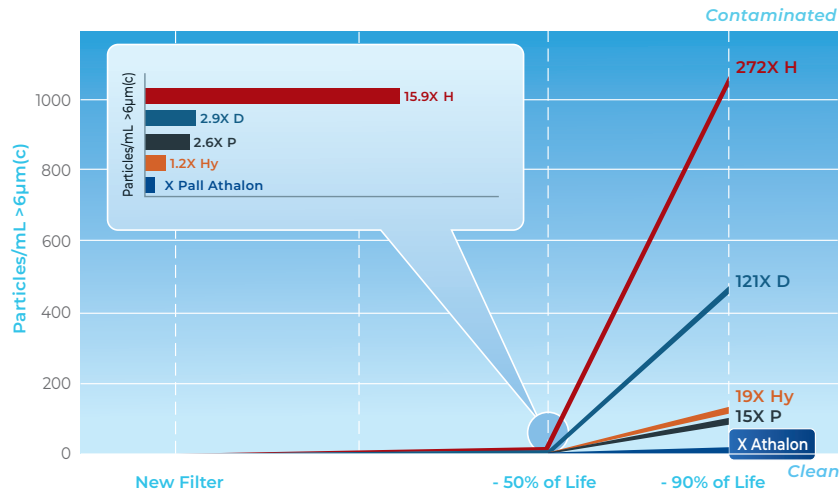

Filter Performance Parameters

Clean Pressure Drop

- Differential pressure across a filter when it is first put into service
- Influencing factors:
 - Absolute viscosity (kinematic viscosity x density)
 - Flow rate
 - Filtration medium pack construction
 - Filter element geometry/construction

Dirt Holding Capacity (DHC)

- Dirt Holding Capacity is the amount of test dust that is required to increase the filter element ΔP to a specified terminal ΔP in the Multi-pass filter performance test

Service Life

- Service life is the length of time that a filter is in an actual system before the differential pressure indicator actuation point is reached

Collapse Rating (ISO 2941)

- A filter's collapse rating is expressed at two different differential pressures
 - ISO collapse pressure – when the slope of the ΔP build-up curve begins to flatten, indicative of filtration performance degradation - point A
 - Physical collapse pressure – when the filter element hardware is damaged (e.g. core collapse) - point B
- Proper filter element support structure maximizes the filter's collapse rating. A bypass valve (set sufficiently lower than the filter's ISO collapse rating) is typically installed in the filter housing to prevent ISO collapse

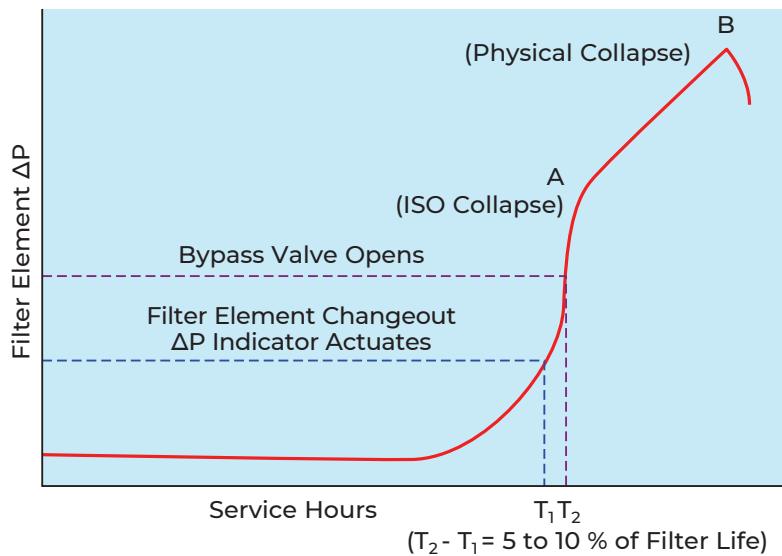

ΔP across the filter increases as contaminant is trapped within the filtration medium. A ΔP indicator is used to signal the need for element change before the bypass relief valve opens. The bypass valve protects the filter and system from excessive differential pressure.

Without a bypass valve, continued operation at higher differential pressures risks degradation of filtration performance (point A) and filter element collapse (point B) where the integrity of the filter element is lost.

Service Life vs. Dirt Holding Capacity (DHC)

Apparent Dirt Capacity

Apparent dirt capacity is the amount of dirt that is added to the Multi-pass filter test system before filter element terminal ΔP is reached.

Retained Dirt Capacity

Retained dirt capacity is the amount of dirt that is captured by the filter in the Multi-pass test system before filter element terminal ΔP is reached.

Test variables that affect DHC include:

- Flow density (flow rate/filtration area)
- Contaminant size distribution
- Contaminant ingress rate
- Terminal differential pressure
- Fluid viscosity
- Filtration efficiency

Additional variables that affect service life:

- Actual operating conditions
 - Contaminant type/distribution
 - Contamination load rates and variations in loading
 - Vibration and other operating conditions
- Fluid cleanliness level achieved
- Differential pressure indicator settings (reset/reliability)

Comparing dirt capacity of two filter elements

- All variables above must be equal
- Elements must be of equivalent size
- Elements must be of equivalent efficiency
- Retained dirt capacity values must be compared

Comparative Laboratory vs. Field Test Results:

	Lab DHC	% Difference	Field Service Life	% Difference
Filter A	75 g	13 %	3.5 months	14 %
Filter B	85 g		4.0 months	
Filter C	70 g	43 %	1.5 months	167 %
Filter D	100 g		4.0 months	
Filter E	70 g	100 %	1.0 month	150 %
Filter F	140 g		2.5 months	

The results above illustrate why Dirt Holding Capacity (DHC) should not be used to predict filter element service life due to the many variables that affect service life in actual applications.



Water Contamination in Oils

Water Contamination in Fluid Systems Causes

- Fluid breakdown (e.g., additive precipitation, oxidation)
- Reduced lubricating film thickness
- Accelerated metal surface fatigue
- Corrosion
- Loss of dielectric strength in insulating fluids

Sources of Water Contamination

- Heat exchanger leaks
- Seal leaks
- Condensation of humid air
- Inadequate reservoir covers
- Temperature reduction (turning dissolved water into free water)



Forms of Water in Oil

- Free (emulsified or continuous phase)
- Dissolved (below saturation)

Typical Oil Saturation Levels*

- **Hydraulic:**
200-400 PPM (0.02-0.04 %)
- **Lubrication:**
200-750 PPM (0.02-0.075 %)
- **Dielectric:**
30-50 PPM (0.003-0.005 %)
- **Industrial Phosphate Ester:**
1,000-3,000 PPM (0.1-0.3 %)

**Actual levels will depend on oil type and additives.*

When oil becomes cloudy or milky in appearance, the saturation limit at the oil temperature has been exceeded, indicating that both dissolved and free water are present.

To minimize the harmful effects of free water, water concentration in oil should be kept as far below the oil saturation point as possible. A maximum saturation level of 50 % is recommended at operating temperature. Dielectric fluids should be maintained at lower saturation levels.

Typical Water Saturation Curve

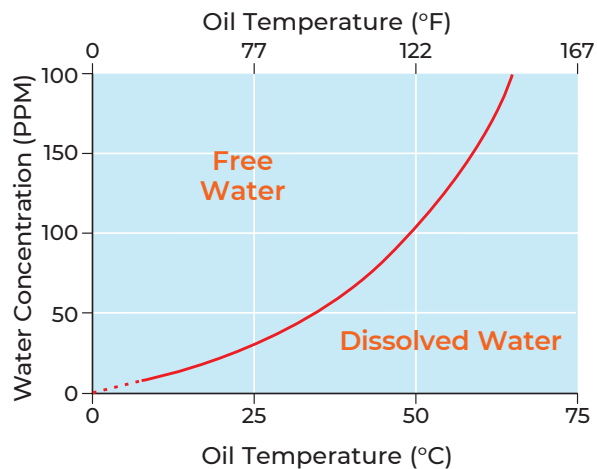

Ref: EPRI CS-4555 Turbine oil

Water Concentration

10,000 PPM	1 %
1,000 PPM	0.1 %
100 PPM	0.01 %

Water Measurement Methods

Method	Units	Benefits	Limitations
Crackle Test	None	Quick indicator of presence of free water	Not quantitative; Does not permit detection below saturation
Chemical (Calcium hydride)	% or PPM	A simple measurement of water content	Not very accurate for dissolved water
Distillation	%	Unaffected by oil additives	Limited accuracy on dry oils; Low boiling fractions can interfere with results
FTIR	% or PPM	Quick water measurement	Not accurate at low water concentrations; May have interference from fluid components
Karl Fischer	% or PPM	Accurate at detecting low levels of water (10 - 1,000 PPM)	Not suitable for high levels of water; Can be affected by fluid components
Capacitive Sensor (Water Sensor)	% of saturation or PPM	Quick detection of dissolved water (0 - 100 % of saturation) On or off-line capability	Cannot measure water levels above saturation (100 %)

Principle of Water Sensors

- The dielectric of the polymer changes as the water is absorbed
- The capacitance change is proportional to water concentration

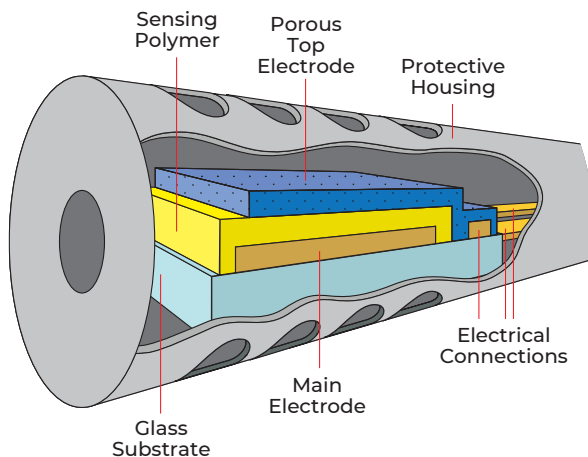

These Water Sensors can be installed permanently on the system return lines. This on-line monitoring enables Operators to implement immediate corrective actions on their system in case of sudden water ingress

PPM Measurement vs. % Saturation

- PPM provides a measurement of absolute water concentration and is used for specifying water concentration limits. It is independent of fluid temperature
- % saturation provides a measure of the water content relative to the fluid's water saturation point at the measurement temperature
- % saturation provides a meaningful indication of free water formation without the need to know the saturation point

Saturation Point vs. Temperature

- While saturation curves for specific fluids can be determined via laboratory analysis, saturation curves are not readily available, even from the fluid manufacturer

Example: If a Water Sensor is used with the example hydraulic oil and reads 70 % saturation at 40 °C, the water content would be 210 PPM (70 % saturation x 300 PPM = the saturation point at 40 °C).

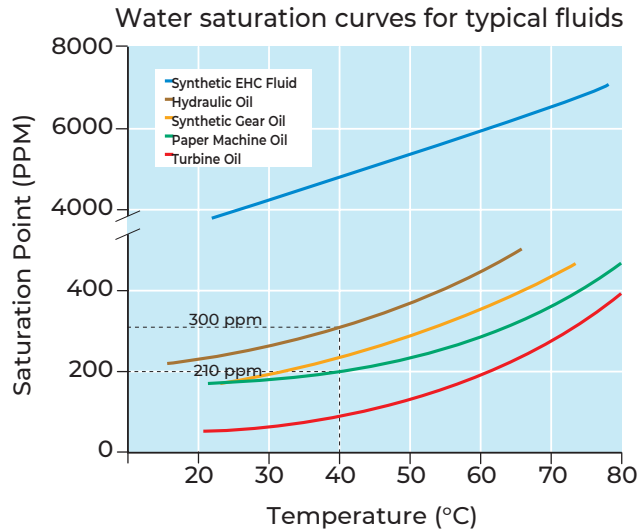

Detrimental Impact of Water on Fluids - Thermo-oxidative stability

While water and metal catalysts each have an impact on a fluid's thermo-oxidative stability, when both are present, the impact can be greatly magnified.

Item	Catalyst	Water	Hours	Final Neutralization Number
1	None	No	3,500+	0.17
2	None	Yes	3,500+	0.90
3	Iron	No	3,500+	0.65
4	Iron	Yes	400	8.10
5	Copper	No	3,000	0.89
6	Copper	Yes	100	11.20

Reference: Weinschelbaum, M., Proceedings of the National Conference on Fluid Power

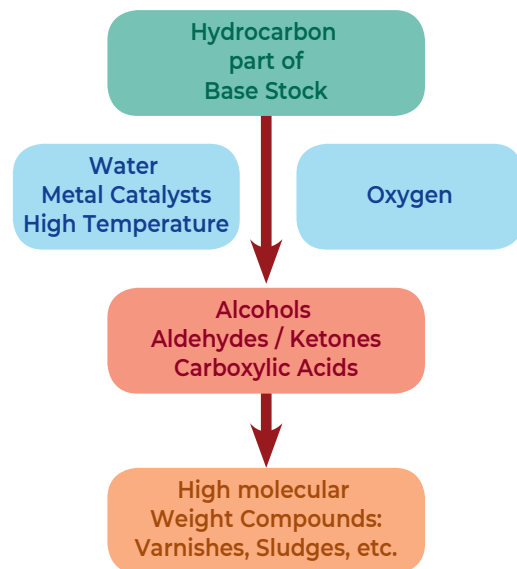

Detrimental Impact of Water on Fluids - Additive Precipitation

Additives can precipitate from the fluids as solids due to:

- Presence of significant concentrations of water
- Mixing of different fluid brands or different types of fluids

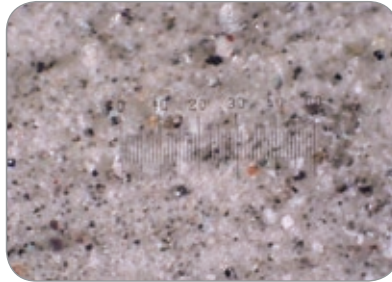
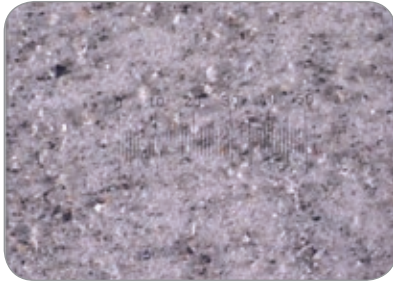

Precipitate of calcium/sulfur containing additive in paper machine lube oil

Detrimental Impact of Water on Gear and Vane Pumps

Pump Sensitivity to Water Contamination

Gear Pump Wear Testing with AC Fine Test Dust, 0-30 µm Fraction		
Fluid condition	Reduction in volumetric efficiency after 30 minutes	
Dry Fluid	8 %	
Fluid with 1 % (10,000 PPM) water	33 %	
Vane Pump Wear Testing		
Fluid condition	Component mass loss (mg)	
	Oil X	Oil Y
Dry Fluid	60	40
Fluid with 500 PPM water	130	28,000

Reference: Fluid Power Research Center, Oklahoma State University

Detrimental Impact of Water on Roller Bearings

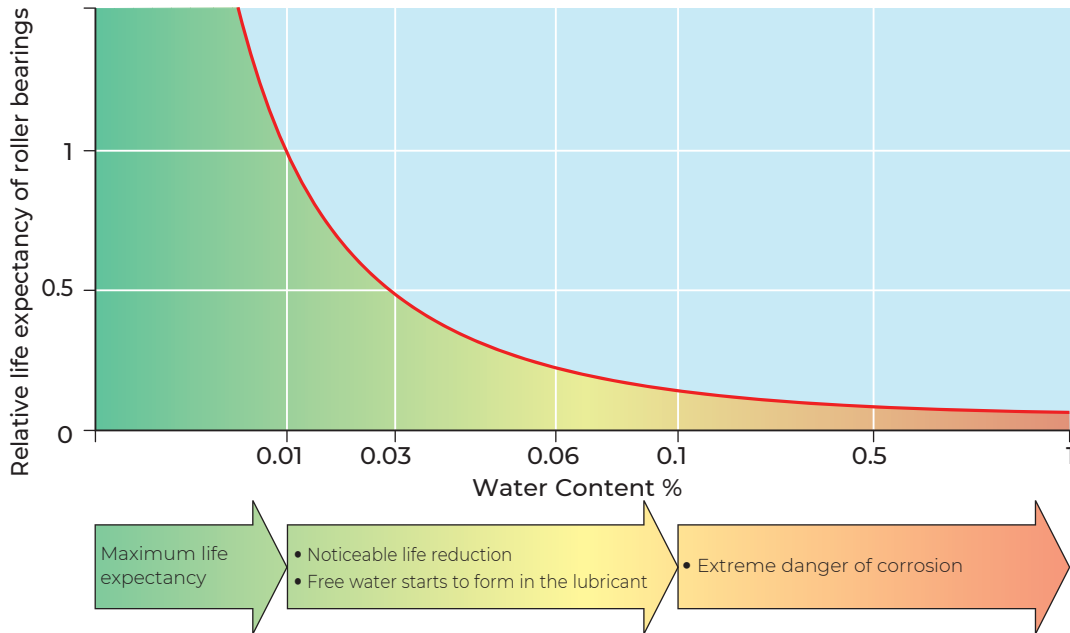

Co-authored by FAG-Pall, 'Life reduction of roller bearings as a function of the water content in the lubricating oil'

The influence of water on the service life of rolling element bearings must not be underestimated since water causes damage such as:

- Fatigue life reduction
- Wear
- Component corrosion

Controlling Water Contamination

Coalescence

- Removes only free water

Centrifugation

- Removes only free water

Absorption

- Removes only free water, optimum performance on low flow and low viscosity applications; can be quick but expensive

Flash Distillation

- Utilizes high heat and vacuum to remove free and dissolved water; high heat could lead to thermal degradation of the oil

Vacuum Dehydration

- Removes free and dissolved water and gases

Vacuum dehydration is the best method for the removal of free and dissolved water at minimum cost and ease of use. It does not “burn” or otherwise significantly alter the working properties of the oil.

Principle of Vacuum Dehydration

Vacuum Dehydration

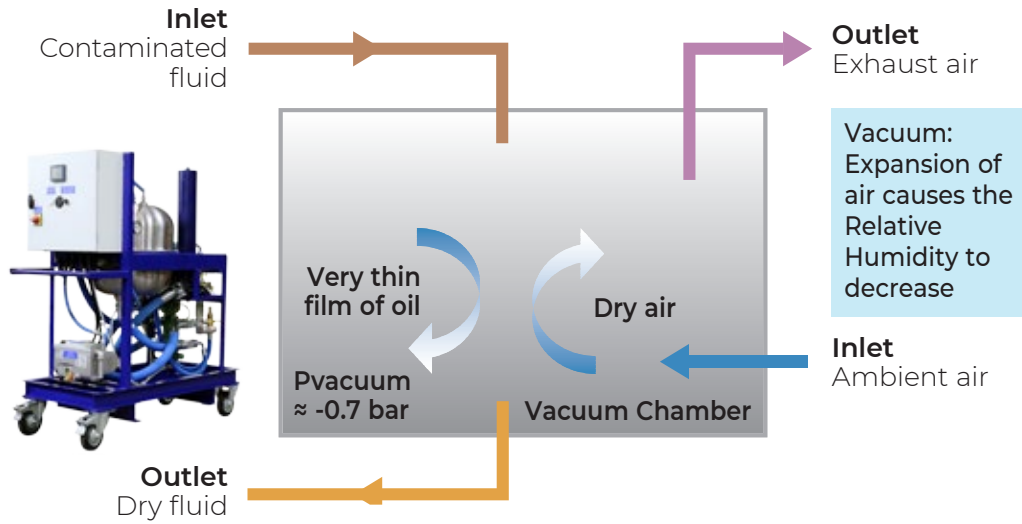

Note: To increase the exchange surface area between the contaminated fluid and the dry air, the HNP and HDP series use respectively a nozzle assembly and a bulk of Raschig rings

Typical Water Removal Rate

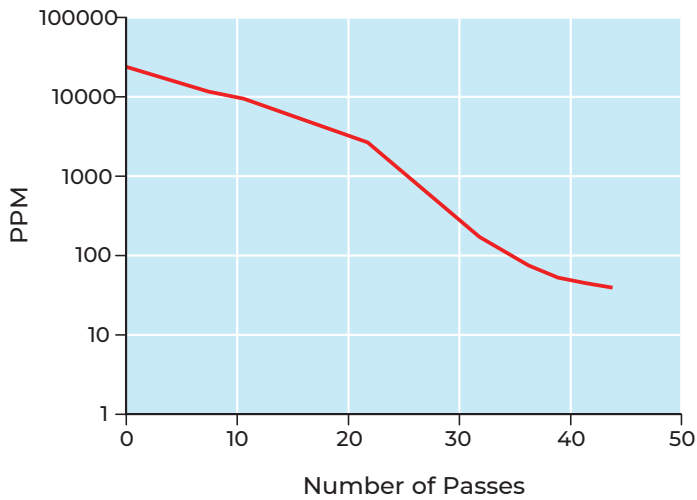

Test performed at 60 °C (140 °F) on a 120 L (30 US gal) volume. Fluid: DTE 797 turbine oil

Controlling Water Contamination

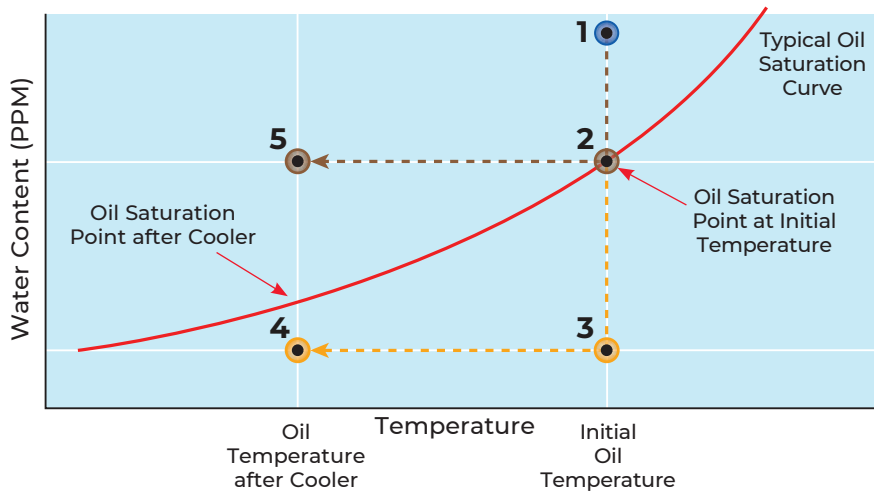

- | | |
|--|---|
| <ol style="list-style-type: none"> 1 Initial water content is above saturation (free water). 2 Maximum water removal capability of 'free water removal' devices (coalescers, centrifuges, etc.) is to the oil's saturation point. 3 Water content achieved with vacuum dehydration is significantly below the oil's saturation point. | <ol style="list-style-type: none"> 4 Water content achieved with vacuum dehydration remains below the oil's saturation point even after oil is cooled by the system heat exchanger. This prevents the formation of free water which is detrimental to fluid system components and the fluid. 5 If only free water is removed at initial temperature, when oil is cooled the amount of free water in the oil can increase significantly. |
|--|---|

Performance Comparison between Technologies

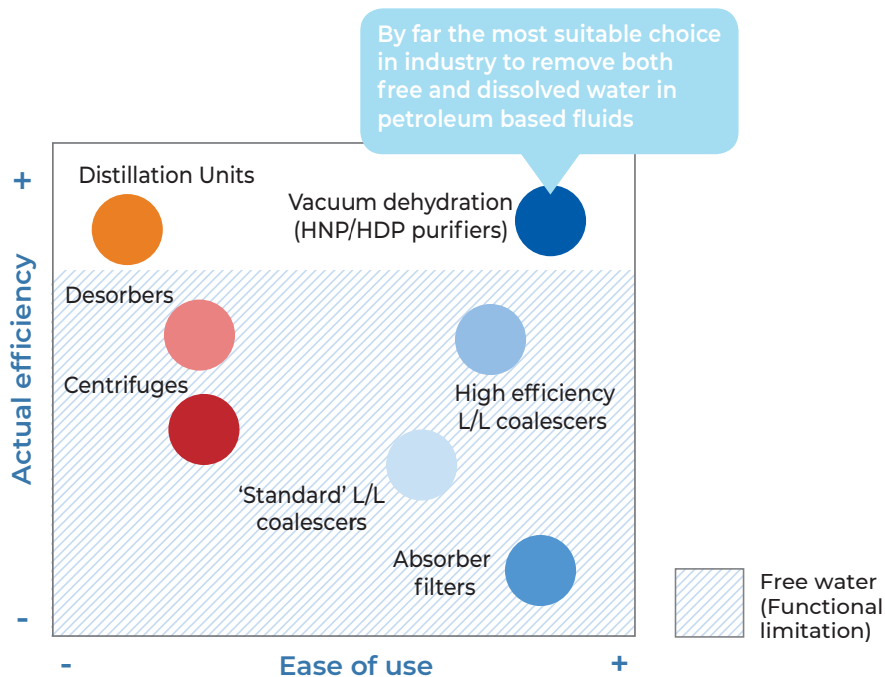

Separation Technologies – Liquid/Liquid Coalescence

Technical Principle

There are 3 essential phase separation steps to ensure efficient L/L coalescence performance:

1- Preconditioning of the fluid

minimize solids in the coalescer influent that can plug the coalescer, reducing the overall life and efficiency (typical prefiltration from 2 μm to 40 μm absolute)

2- Coalescence of the dispersed phase

merge small droplets of liquid into larger ones as the fluid stream passes through

several layers of filter media, each with progressively larger pores.

3- Separation of the dispersed phase from the continuous phase

separate large droplets once they are formed. Depending on the liquid to be separated, a separator cartridge can be provided which has “repelling” properties toward the coalesced liquids. Alternatively, the assembly can be designed to allow time for the coalesced liquid to settle

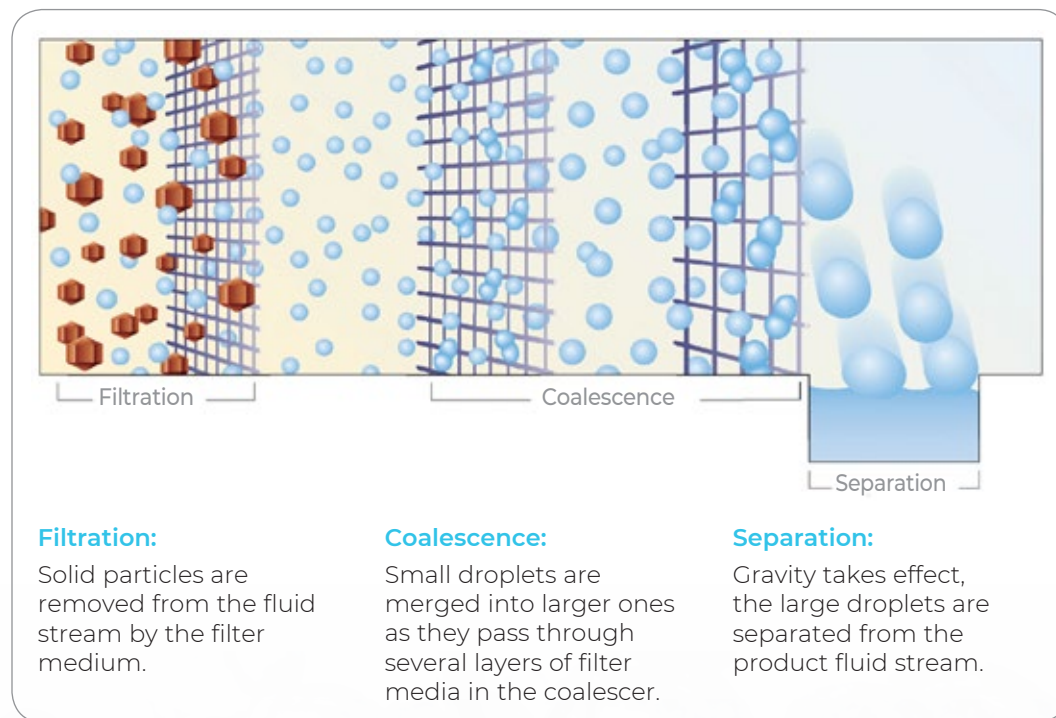

Filtration:

Solid particles are removed from the fluid stream by the filter medium.

Coalescence:

Small droplets are merged into larger ones as they pass through several layers of filter media in the coalescer.

Separation:

Gravity takes effect, the large droplets are separated from the product fluid stream.

The lower the interfacial tension, the more stable the emulsion and the more difficult the liquids are to separate. Conventional coalescers begin to lose efficiency when the interfacial tension is below 20 dyne/cm. Pall coalescers separate liquids with interfacial tensions as low as 0.5 dyne/cm. Pall L/L coalescers feature polymeric media that does not disarm in presence of surfactants or additives.

Performances and specifications of high efficiency L/L coalescers

- Inlet liquid contaminant concentration usually up to 3% (in some rare cases, up to 10%)
- Effective on emulsion with Interfacial tension below 20 dynes/cm (emulsion stability)
- Down to 15 ppmw above solubility limit
 - Water from gasoline:
 - <15 ppmv of free water outlet
 - Clear and bright
 - Liquid hydrocarbon from water
 - <20 ppmw free hydrocarbon
 - Clear and bright

The coalescer size and type are determined by numerous factors: physical properties of the fluid (especially Interfacial tension), flow rate, process conditions and chemical compatibility with process fluids and additives. Pilot tests are recommended to size a full-scale L/L coalescence unit for non-standard applications.

Typical applications

- Separation of water from gasoline, jet fuel and diesel
- Separation of caustic from gasoline, jet fuel and diesel
- Separation of water from light hydrocarbons (C6 and below) and petrochemicals
- Separation of acids from petrochemicals and hydrocarbons
- Separation of oil from water and anhydrous ammonia



Liquid/Liquid coalescers separate water from hazy diesel and oil from wastewater, providing contaminant-free products

Air Contamination in Oils

Forms of Air in Hydraulic and Lubricant Fluids

- Free or emulsified air
- Dissolved air
 - Solubility is a function of temperature, pressure and fluid composition (solubility increases with temperature and pressure)

Sources of Air Contamination

- Ingression through reservoir vents and system vents
- Change in fluid temperature/pressure in the system
 - Dissolved air can be released as free air
- Leakage through seals
- Fluid top-off

Detrimental Effects of Air Contamination

- Sluggish response and control of hydraulic actuators
- Cavitation
 - High temperature (fluid degradation)
 - Surface pitting (pumps and gears)
- Loss of lubrication film
- Accelerated oxidation of the fluid
- Reduced fluid viscosity
- Lower flash point (solvents, lighter hydrocarbons)
- Fluid compressibility

Controlling Air Contamination

- Air bleed valves (free air)
- Fluid purifiers (free and dissolved air)
- Centrifuges (free air)



Air contamination causing foaming in lubricant reservoir



Fluid samples taken upstream and downstream of a purifier

Cavitation

Air in liquid enters a pump where mechanical forces create and collapse air bubbles. This action creates 1) pressure waves that cause pump surface pitting and flaking, and 2) temperature spikes that damage the fluid. Results include reduced pump efficiency, short pump life, and fluid degradation.

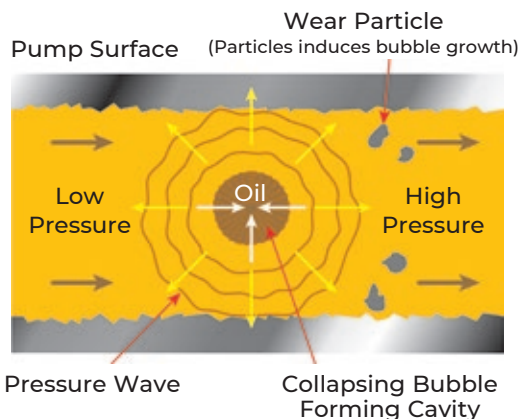

Triboelectric Charging and Electrostatic Discharge

Frictional contact between fluid and surfaces of various materials in the fluid system can result in charge transfer between the fluid and material resulting in electrostatic charging, termed triboelectric charge generation.

Extent of Charge Generation Depends on:

- Nature of the material and fluid; non-polar materials yield higher charging
 - Fluid velocity; higher velocity yields higher charging
 - Fluid viscosity; higher viscosity yields higher charging
 - Fluid conductivity; lower conductivity yields higher charging
 - Moisture content; lower moisture content yields higher charging
 - Contact area; higher contact area yields higher charging
- Filter surface area; triboelectric charging between the fluid and filtration medium can be significant due to the large surface area and full flow characteristics of filter elements



Discharge from filter housing to grounded alligator clip

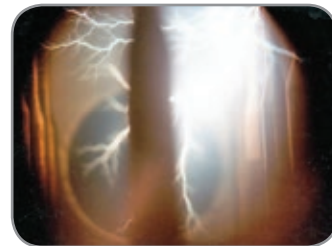

Electrical discharge occurring inside oil tank

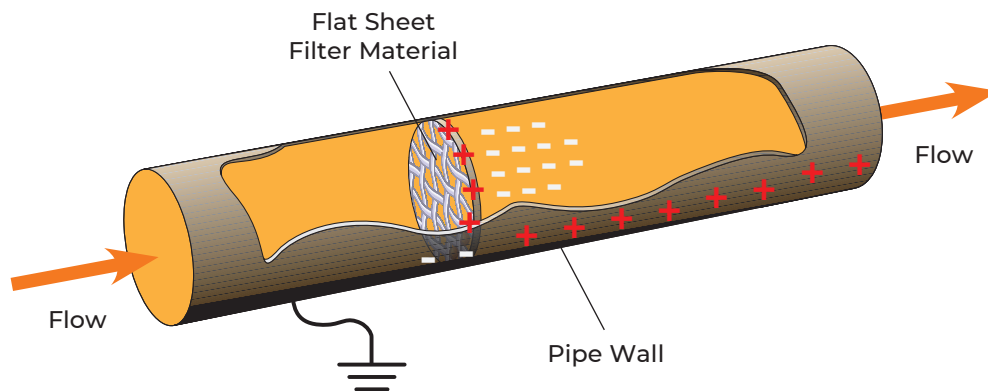

Detrimental Effects of Triboelectric Charging (TEC)

- Arcing and physical damage to fluid system components (heat exchangers, flowmeters, valves, filter housings and filter elements)
- Reduced contamination control (contamination in fluid system – detrimental effects of contamination and contamination induced component wear, etc.)
- Fluid break down (thermal degradation/varnish formation, premature additive depletion, reduced fluid service life)
- Safety – electrical arcing can pose a safety hazard

Principal Fluid System Types Where Triboelectric Charging has been Observed:

- Power generation turbine lubrication systems
- Paper machine lubrication systems
- Plastic injection molding fluid systems
- Primary metals hydraulic systems

Why are Today's Lube Oil Systems More Prone to ESD?

Because modern lube oils are often:

- Highly refined API group II oils – less polar, low conductivity

Because modern lube systems are:

- Smaller with lower fluid volume
High fluid turnover. Higher velocity, Less time for charge dissipation
- Have higher flow rate through filter
Higher flow density → Higher charge generation
- Use finer filtration
Synthetic, borosilicate fiber filter media
Higher surface area → Higher charge generation

Use of highly refined oils & finer, borosilicate fiber filter media is a major cause of ESD in turbine lube systems

Measuring Triboelectric Charging

Triboelectric Charge Measurement Test Setup

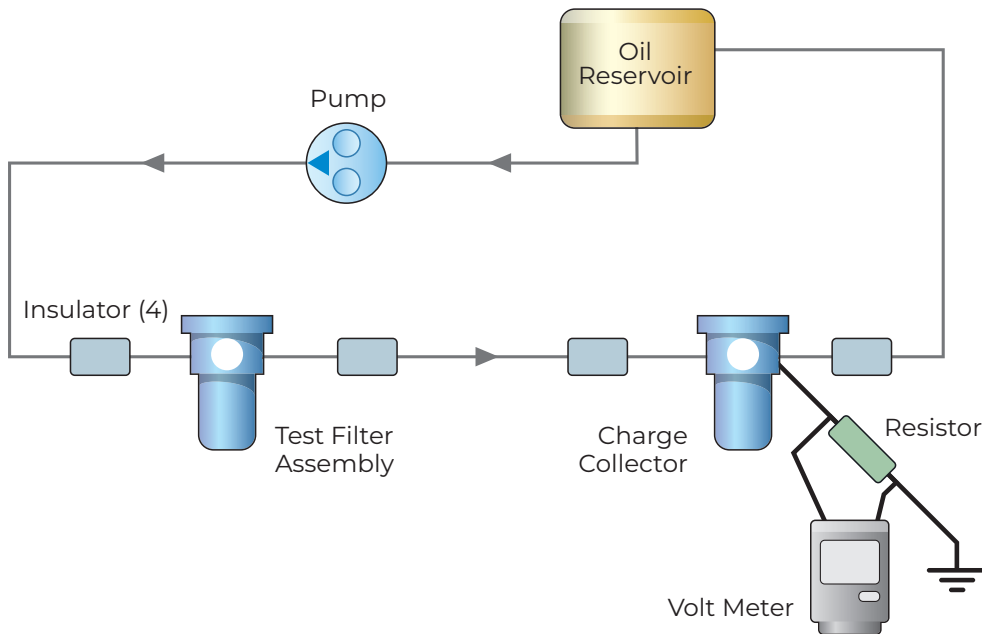

Anti-static Filters

Filter elements designed to dissipate triboelectric charge build-up cannot eliminate triboelectric charging but can

- Minimize electrostatic discharge/arcing
- Minimize charge generation and prevent discharging
- Minimize fluid degradation and varnish formation

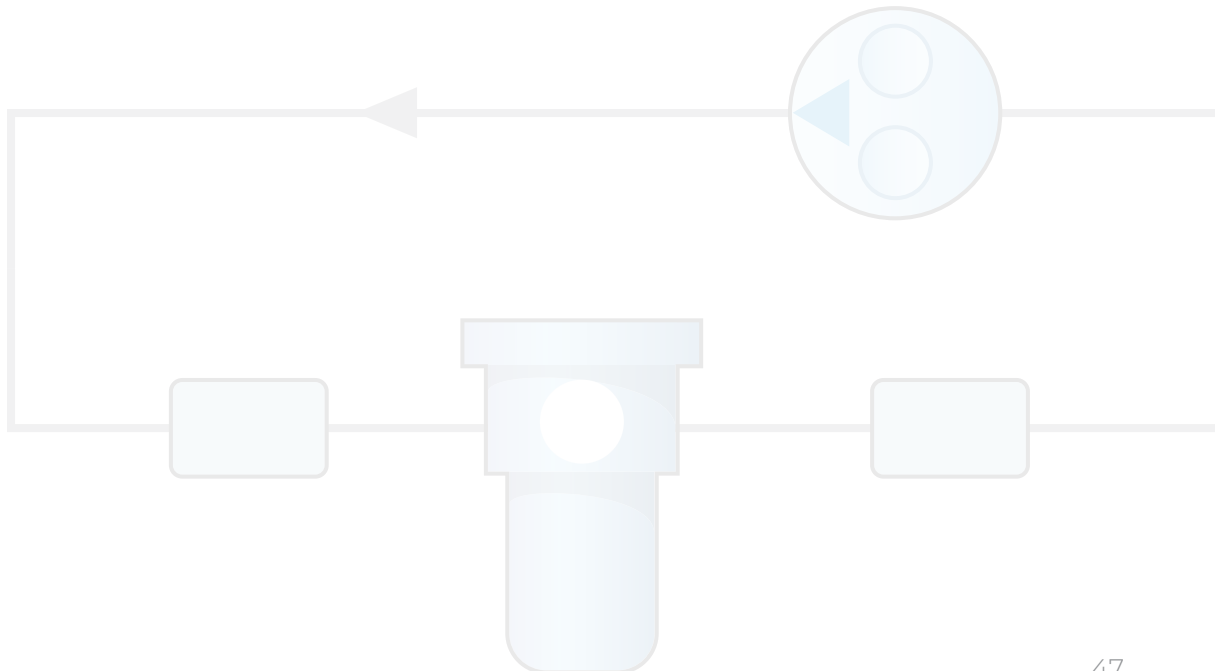
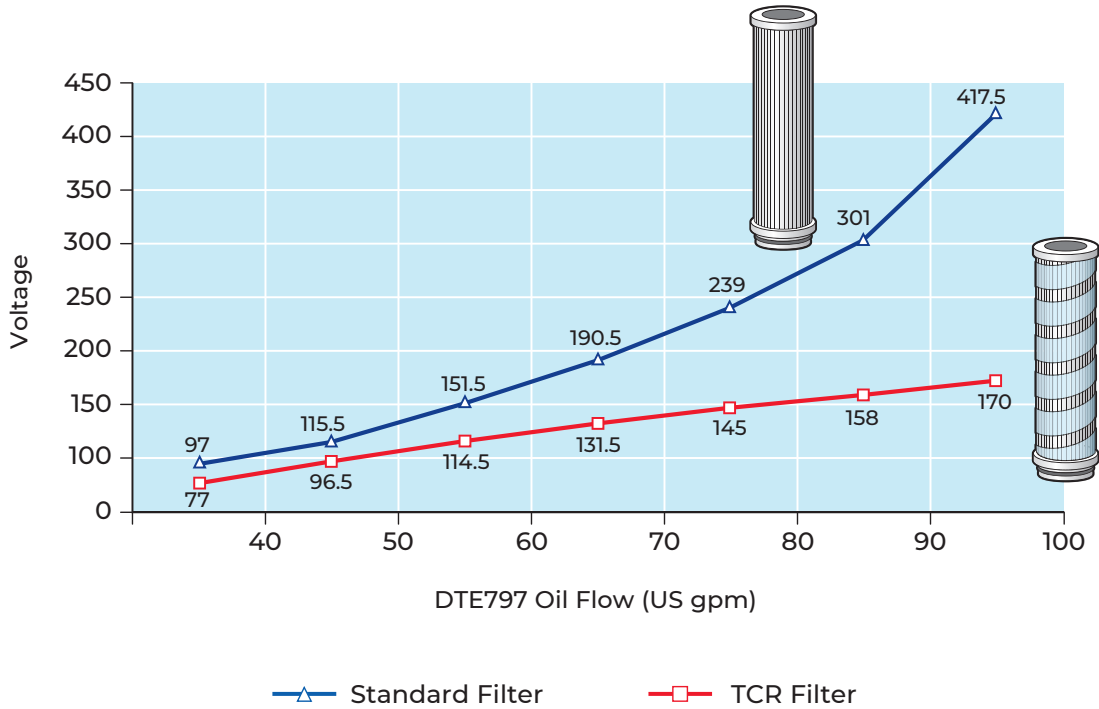

What is "Varnish" ?

- High-molecular weight compounds formed by thermo-oxidative degradation of lubricants and hydraulic fluids
- When in the fluid, these compounds are often described as "varnish precursors".
They can exist in the fluid as a solid, gel, or in solution
- "Varnish precursors" can form thin, insoluble deposits on critical surfaces throughout the fluid system, commonly referred to as "varnish"
- Varnish has adverse effects on functional properties of fluid and on components like servo-valves and bearings

Typical effect on varnish on a valve spool:

- Slow, inaccurate and unstable response
- Spool jamming
- Solenoid burnout



Varnish Formation Mechanisms

Three main pathways for fluid degradation¹

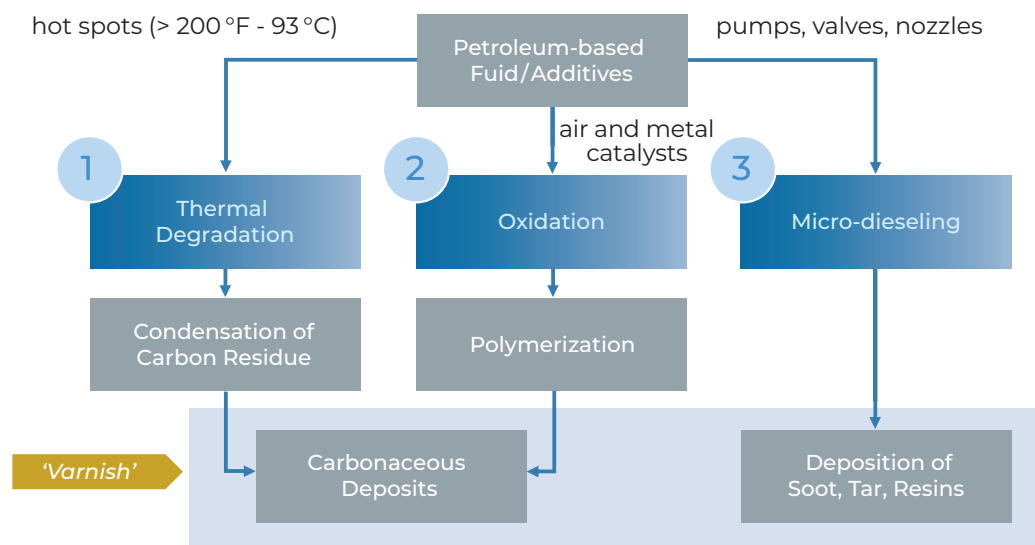

¹: Fitch, JC, "Sludge and Varnish: Two Puzzling Contaminants", *Hydraulics and Pneumatics*, Vol. 53, Dec 2000, pp. 36-38

Fluid degradation and formation of varnish – Influencing factors

- Heat, hot spots
- Machine load and duty cycles
- Electrostatic discharge
- Adiabatic compression (micro-dieseling) and collapse of entrained air in high pressure areas
 - e.g. high pressure pump inlets – see below

Common applications where varnish occurs:

- Injection molding machines
- Stamping presses
- Gas/Steam turbines
- Compressors

Severe fluid working conditions, typically either high cycling or high temperature applications

Guidelines for Varnish Identification

If any of these indicators are present, it is highly recommended to perform laboratory analyses (Spectrophotometry or Colorimetry) to assess the presence of varnish (ASTM D7843 standard)

- Dark colored oil
- Oil sample with acidic odor
- High TAN
- Presence of non particulate silt on a 0.8 or 1.2 μm test membrane
- High operating temperature or hot spots in the system (> 176 °F, >80 °C)
- High 4 μm (c) APC* counts not in line with the test membrane (e.g. ISO cleanliness code of 20/14/10)
- Servo-valve failure, Last Chance Filter clogging in cold pilot lines
- Premature filter clogging
- Sticky residue on system components

*Automatic Particle Counter

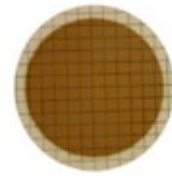

Presence of varnish



No varnish

Varnish Control Methods

- Chemical Cleaning/Flushing
- Electrostatic Method
- Ion Exchange Resins

Adsorptive Filters – Preferred methods for hydraulic systems:

- Varnish precursors are trapped within filtration medium through weak molecular forces (e.g. van der Waal's forces)
- Media construction:
 - Cellulose fibers** – creating a porous matrix for:
 - ▶ Integration of additives
 - ▶ Providing strength and handling
 - Additives** – Perlite, Diatomaceous earth, activated carbon
 - Resins** – Macromolecules for:
 - ▶ Surface charge modification
 - ▶ Adsorption
 - ▶ High burst strength

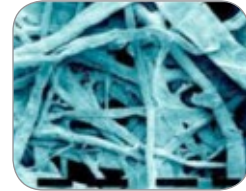

Adsorptive Filter Medium

Advantages

- Preventive maintenance oriented technology – slows down fluid degradation
- Low flow density – Maximizes adsorption and favors caking
- Cost effective – High retention capacity and long service life
- Ease of use & installation – kidney loop filtration with simple maintenance (module change-outs)

Disadvantages

- Low flow density - Not ideal for large reservoirs
- < 40°C Fluid Temperature is highly recommended to address insoluble 'varnish precursors'; higher temperatures have higher probability that precursors will be dissolved

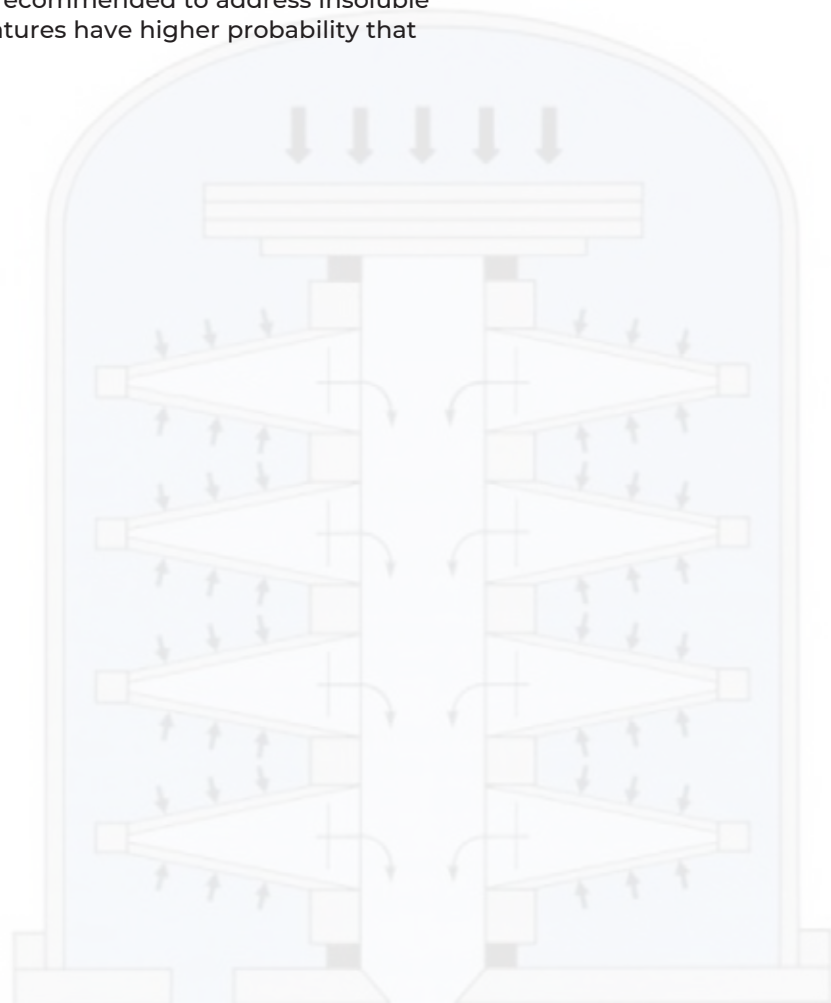

Adsorptive Filtration Technology

- How it works - Example

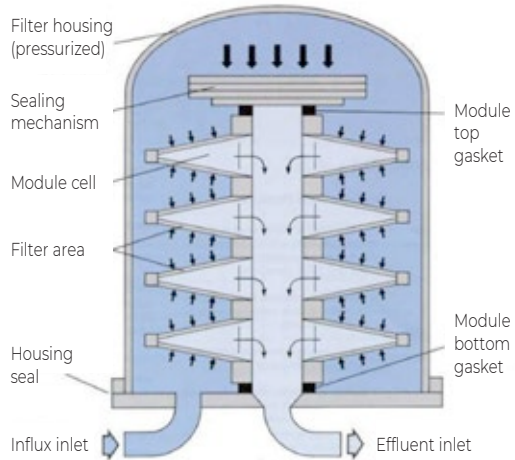

FILTRATION TECHNOLOGY REQUIRING A LOW FLOW DENSITY, ADSORPTIVE FILTERS WORKING IN RECIRCULATION (OFF-LINE)

- Typical element



Lenticular Filter Module

- Typical Retention Rates

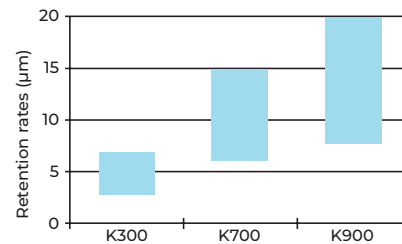

Applied to Hydraulic & Lube applications



Wide variety of benefits in Hydraulic & Lubrication systems

- Remove varnish
- Improve fluid filterability properties
- Retain fine contaminants @ high loading rate
- Remove traces of free water in oil
- Recover used oil (if oil compounds not degraded)

Target Markets and Typical Applications

- Automotive industry (function tester, oil recovery)
- Heavy industry (lubrication)
- General industry (oil recovery)
- Powergen (turbine lubrication)

Determining Required Fluid Cleanliness Levels

Fluid Cleanliness Level Worksheet*

Selection of the appropriate cleanliness level should be based upon careful consideration of the application's operational and environmental conditions and requirements. By completing this worksheet, a total weighting can be obtained and the Required Cleanliness Level (RCL) can be identified from the graph on page 53.

Table 1. Operating Pressure and Duty Cycle

Duty	Examples	Operating Pressure (bar (psi))					Actual
		0-70 (0-1,000)	>70-170 (>1,000-2,500)	>170-275 (>2,500-4,000)	>275-410 (>4,000-6,000)	>410 (>6,000)	
Light	Steady duty	1	1	2	3	4	
Medium	Moderate pressure variations	2	3	4	5	6	
Heavy	Zero to full pressure	3	4	5	6	7	
Severe	Zero to full pressure with high frequency transients	4	5	6	7	8	

Table 2. Component Sensitivity

Sensitivity	Examples	Weighting	Actual
Minimal	Ram pumps	1	
Below average	Low performance gear pumps, manual valves, poppet valves	2	
Average	Vane pumps, spool valves, high performance gear pumps	3	
Above average	Piston pumps, proportional valves	4	
High	Servo valves, high pressure proportional valves	6	
Very high	High performance servo valves	8	

Table 3. Equipment Life Expectancy

Life Expectancy (hours)	Weighting	Actual
0-1,000	0	
1,000-5,000	1	
5,000-10,000	2	
10,000-20,000	3	
20,000-40,000	4	
>40,000	5	

Table 4. Component Replacement Cost

Replacement Cost	Examples	Weighting	Actual
Low	Manifold mounted valves, inexpensive pumps	1	
Average	Line mounted valves and modular valves	2	
High	Cylinders, proportional valves	3	
Very high	Large piston pumps, hydrostatic transmission motors, high performance servo components	4	

Table 5. Equipment Downtime Cost

Downtime Cost	Examples	Weighting	Actual
Low	Equipment not critical to production or operation	1	
Average	Small to medium production plant	2	
High	High volume production plant	4	
Very high	Very expensive downtime cost	6	

* Adapted from BFFA/P5 Target Cleanliness Level Selector 1999 Issue 3. BFFA - British Fluid Power Distributors Association

Table 6. Safety Liability

Safety Liability	Examples	Weighting	Actual
Low	No liability	1	
Average	Failure may cause hazard	3	
High	Failure may cause injury	6	

Table 7. System Requirement

Cleanliness Requirement Total Weighting	Total
Sum of "Actual" weighting from sections 1 through 6	

Using the chart below, determine where the "Cleanliness Requirement Total Weighting" number from Table 7 intersects the red line. Follow across to the left to find the recommended ISO 4406 Code.

Table 8. Environmental Weighting

Environment	Examples	Weighting		Actual
		Single Filter	Multiple Filters*	
Good	Clean areas, few ingress points, filtered fluid filling, air breathers	0	-1	
Fair	General machine shops, some control over ingress points	1	0	
Poor	Minimal control over operating environment and ingress points e.g. on-highway mobile equipment)	3	2	
Hostile	Potentially high ingress (e.g. foundries, concrete mfg., component test rigs, off-highway mobile equipment)	5	4	

* Single filter or multiple filters with the same media grade on the system.

Table 9. Required Filtration Level

Filtration Requirement Total Weighting	Total
Add Environmental Weighting (Table 8) to System Requirement Total (Table 7)	

Using the chart below, determine where the "Required Filtration Level" total in Table 9 intersects the red line. Follow across to the right to find the corresponding recommended Pall filter grade.



†Using on-line particle counting

Lube and Hydraulic Filter Locations

The optimum location for a filter depends on its function...

- If it is for protection of a specific component it must be located directly upstream of that component
- If it is for general wear control, it can be located in any of the major flow lines

Pressure Line

- To stop pump wear debris from travelling through the system
- To catch debris from a catastrophic pump failure and prevent secondary system damage
- To act as a Last Chance Filter (LCF) and protect components directly downstream
- To maintain a specified cleanliness level

- For systems where pressure or return filtration is impractical
- As a supplement to in-line filters to provide improved cleanliness control and filter service life in high dirt ingestion systems
- Can also act as a fill filter

Air Breathers and Fill Filters

- To control the amount of dirt entering the reservoir
- To extend the life of in-line filters
- Must be rated finer than the system filter

Return Line and In-tank

- To prevent debris from component wear or ingestion from travelling to the reservoir and recirculatory through the system
- To promote general system cleanliness

Water Removal Cart (Oil Purifier)

- To control free and dissolved water and gases
- As a supplement to in-line filters to provide improved cleanliness control and filter service life

Off-line or "Kidney" Loop

- To control system cleanliness when main flow diminishes (i.e. compensating pumps)

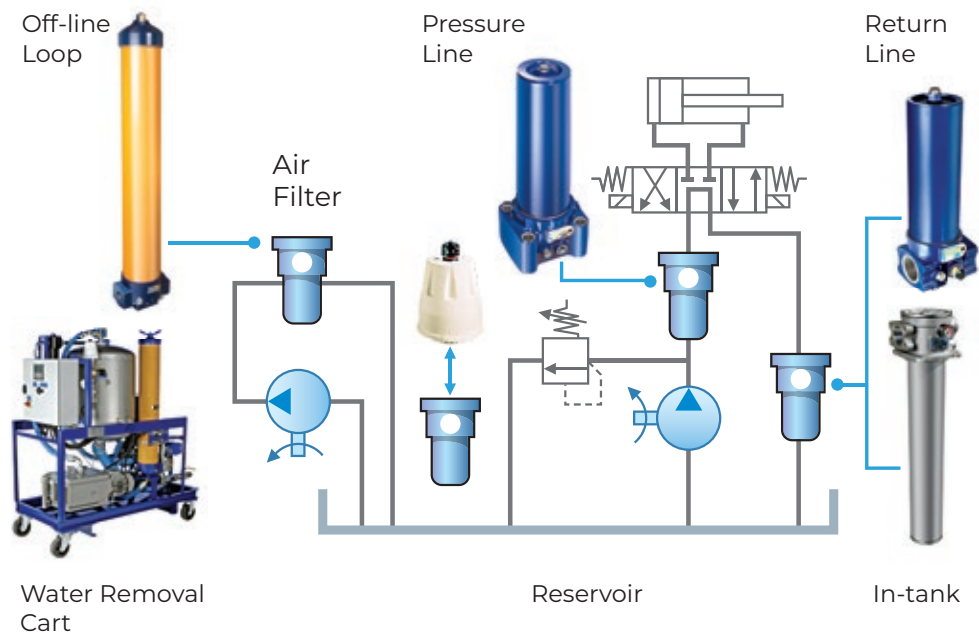

Lube and Hydraulic Filter Sizing - Example

Recommended sizing limits
(Maximum values*)

	Standard Pressure & Return line filters		Return line & In-tank filters with low by-pass valve setting	
	Assembly ΔP	Element ΔP	Assembly ΔP	Element ΔP
Service pressure ≥ 40 bar	1.5 bar	0.7 bar	N/A	N/A
Service pressure < 40 bar	1.5 bar	0.7 bar	0.5 bar	0.4 bar

* Given for clean element

Importance of System Flushing

The aim of flushing is to remove contamination introduced during system assembly or maintenance. This is accomplished by passing clean fluid through the system, usually under turbulent flow conditions higher than that during normal operation, to pick up the particles from surfaces and transport them to the flushing filter.

Omission or curtailment of flushing can lead to rapid wear of components, malfunction and breakdown during commissioning and start-up phases

Reynolds (Re) Number: A non-dimensional number that provides a qualification of the degree of turbulence within a pipe or hose



Laminar Flow

Turbulent Flow

- Laminar Flow: Reynolds Number $< 2,000$
- Transitional Flow: Reynolds Number $2,000 - 4,000$
- Turbulent Flow: Reynolds Number $> 4,000$

For effective flushing procedures the Reynolds (Re) Number should be > 4,000

The flow condition in a pipe or hose can be assessed using Reynolds Number as follows:

$$Re = \frac{Ud}{\nu} \times 1,000 \quad \text{or} \quad Re = 21,200 \times Q / (\nu \times d)$$

Re = Reynolds Number
 U = Mean flow velocity (m/s)
 d = Pipe internal diameter (mm)

ν = Kinematic viscosity of fluid in cSt (mm²/s)
 Q = Flow rate (L/min)

Importance of High Performance Fine Flushing Filter

The flushing filter must have the highest practical Beta rating to greatly reduce flushing time and wear to components.

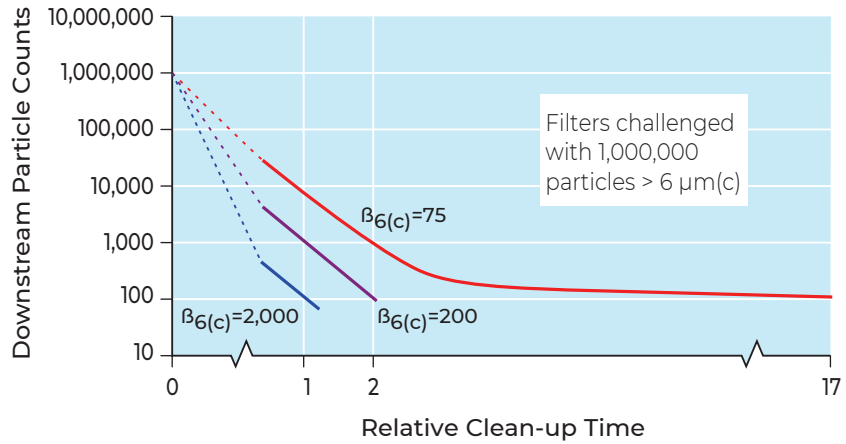

Fluid Sampling Methods

High levels of cleanliness now exist in modern hydraulic and lube systems. The use of sample bottles (for off-line analysis) in the measurement process can introduce substantial errors and can make trend analysis nearly impossible.

Comparison of on-line counting and off-line counting

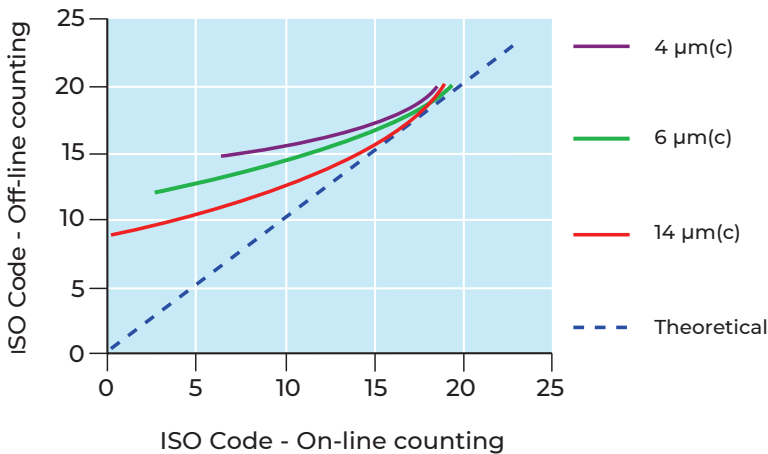

Source: Tampere University of Technology, Finland

At higher contamination levels (higher ISO codes) there is little difference between the two modes of analysis, but as the oil gets cleaner, the level recorded by off-line analysis inaccurately shows the oil to be dirtier compared to on-line analysis.

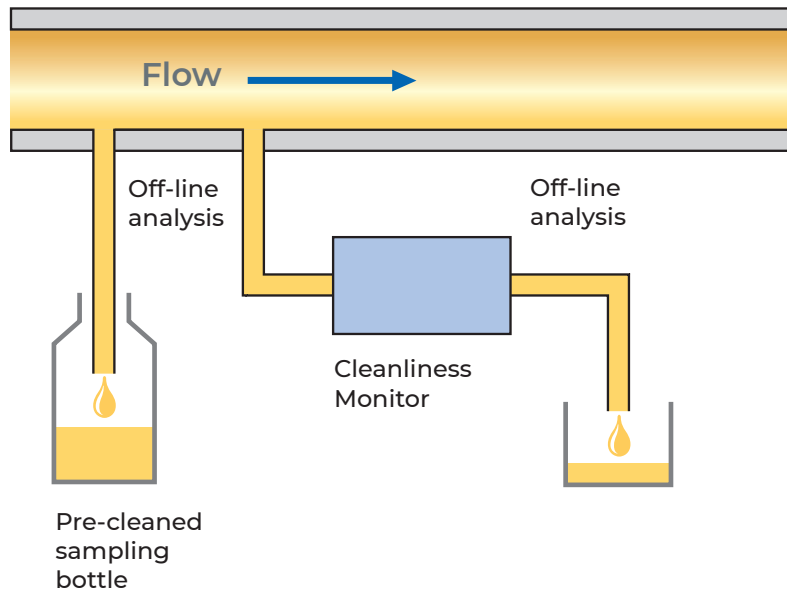

Factors influencing the accuracy of off-line analysis:

- Introduction of environmental dirt into sample bottle
- Incorrect cleaning of sample bottle
- Inadequate flushing of sampling valve
- Effectiveness of sampling process

Fluid Cleanliness levels found in modern hydraulic systems (typ. ISO 4406 codes <15/13/10) require on-line monitoring



Importance of Fluid Filterability on Filter Service Life

Poor fluid filterability properties lead to premature clogging of filter elements

What is Filterability?

- The filterability property of a fluid can be defined as its ability to pass through a filter without giving rise to undue pressure drop which will lead to loss of useful life
- If a hydraulic fluid has a poor filterability, the filter element will block up rapidly, reducing the operating efficiency and increasing the running costs

Typical Causes of Poor Filterability (non-exhaustive list)

- Wear debris due to component deterioration or cross-contamination
- Thermal stressing of oils (cavitation, dieseling)
- Ingression of liquid contaminants (maintenance or process induced)
- Inadequate blending of oils
- Insoluble additives
- Varnish
- Preservatives and coatings

Dynamic Filterability Test

The test is developed to test oils under their working conditions

- Same media grade
- Same operating temperature or range of temperatures
- Same flow density (Flow rate / Filtration Surface Area)
- Operating in recirculation

The test is performed on a bench-sized test rig

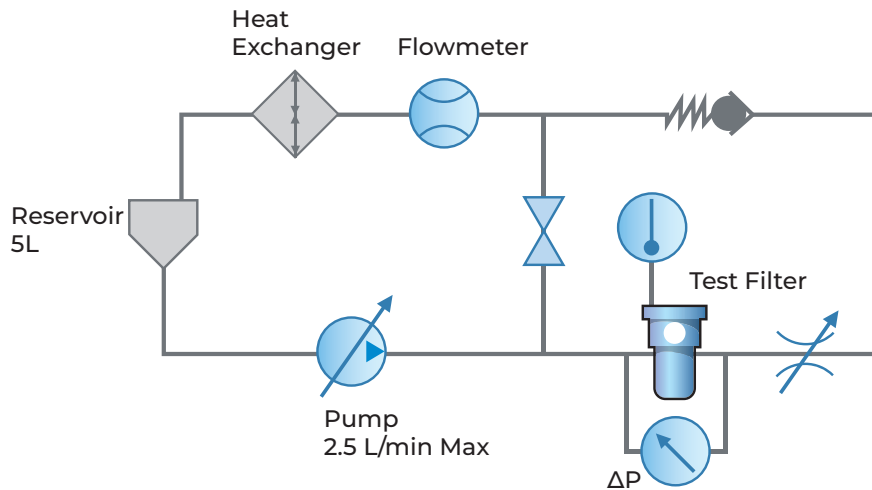

- The dynamic filterability test differs a lot from the Pall-Bensch filterability test by recreating the actual operating conditions in which the filter element is used
- Both hydraulic and lubricating oils can be tested per this method

In the Chart below, all the 4 hydraulic oils have the same viscosity, viscosity index, formulation, etc. **However, in reality, they don't behave the same!**

- Oil B exhibits a very poor filterability where blockage of the filter occurs in a relatively short time. The filter surface is clogging – This is the worst case scenario
- Oil A exhibits an excellent filterability, none of its chemical compounds are retained across the filter medium. This is the ideal case scenario
- Oils C1 & C2 have almost the same DP curve profile, C1 being the first one to stabilize its DP after 8 passes while C2 requires 2 more passes due to the presence of very small particles, called silt. Once stabilized, the DP increase will result from solid contaminants only.

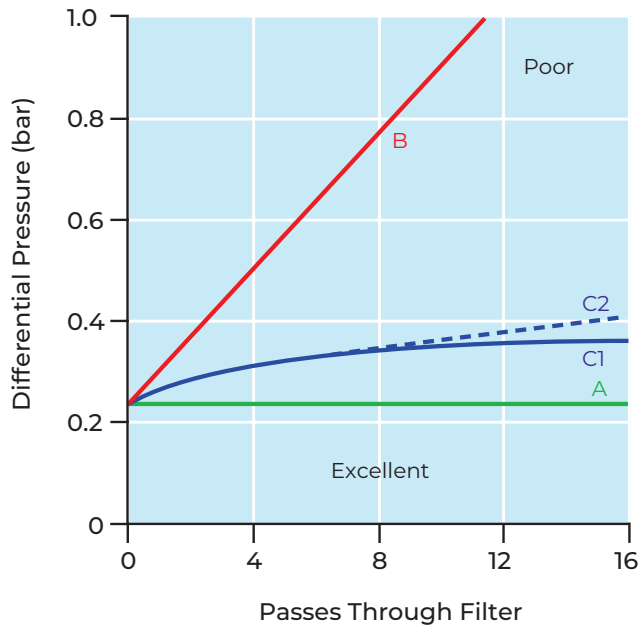

Oil	Filtration Spend
A	Baseline reference! No chemical compounds retained across the filter medium
C1	Higher spend than expected due to some additives in over-concentration helping to clog the filter element
C2	Higher spend than expected due presence of to both chemical & particulate contaminations. DPo ~ 50% higher than Oil A
B	Significantly higher spend due to an over-consumption of filter elements resulting from premature clogging

Pall-Bensch Filterability Test

The Pall-Bensch filterability test is a simple test to perform in the field or in laboratory to calculate the filterability factor of a new fluid (ISO VG 68).

In summary, the test consists of pulling the fluid through a 1.2 µm membrane until it blocks, then calculating a filterability factor (FF) by considering the volume of fluid which has passed through the membrane.

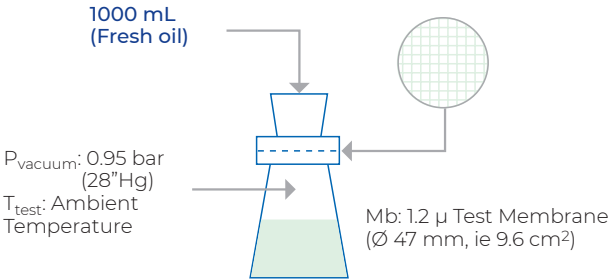

Measure and record the total volume of the test fluid passed through the membrane when the test flow rate becomes less than 1 drop in 2 seconds.

Interpretation of the Filterability Factor

$$FF = \frac{\text{Volume passed (mL)}}{\text{Effective filtration area of the Mb}}$$

$$FF = \frac{\text{Volume passed (mL)}}{9.6}$$

Filtered Volume	V < 300 mL	300 < V < 700	700 < V < 1000	V=1000 mL
Filterability Factor	FF < 31	31 < FF < 73	73 < V < 104	FF=104
Filterability properties	Very poor	Poor	Acceptable	Excellent
Impact on Element SL*				

* Service Life

Importance of Differential Pressure Indicators and Switches

Differential pressure (ΔP) indicators and switches notify the operator of the filter blocking condition. This allows a replacement filter to be installed before filter element bypass occurs.

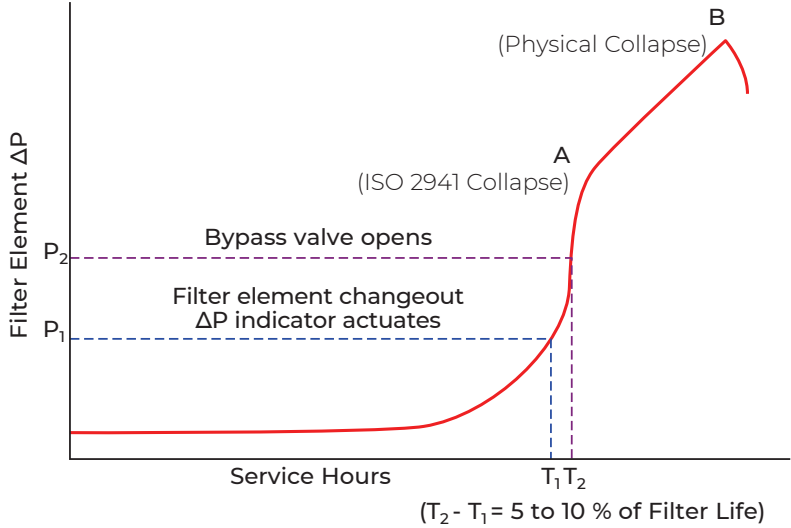

ΔP across the filter increases as contaminant is trapped within the filtration medium. A ΔP indicator actuates at P_1 , signalling the need for element change before the bypass relief valve opens at P_2 .

The bypass valve protects the filter and system from excessive differential pressure. Without a bypass valve, continued operation at higher ΔP risks degradation of filtration performance (point A) and filter element collapse (point B) where the integrity of the filter element is lost.

Mechanical and Electrical Differential Pressure Indicators

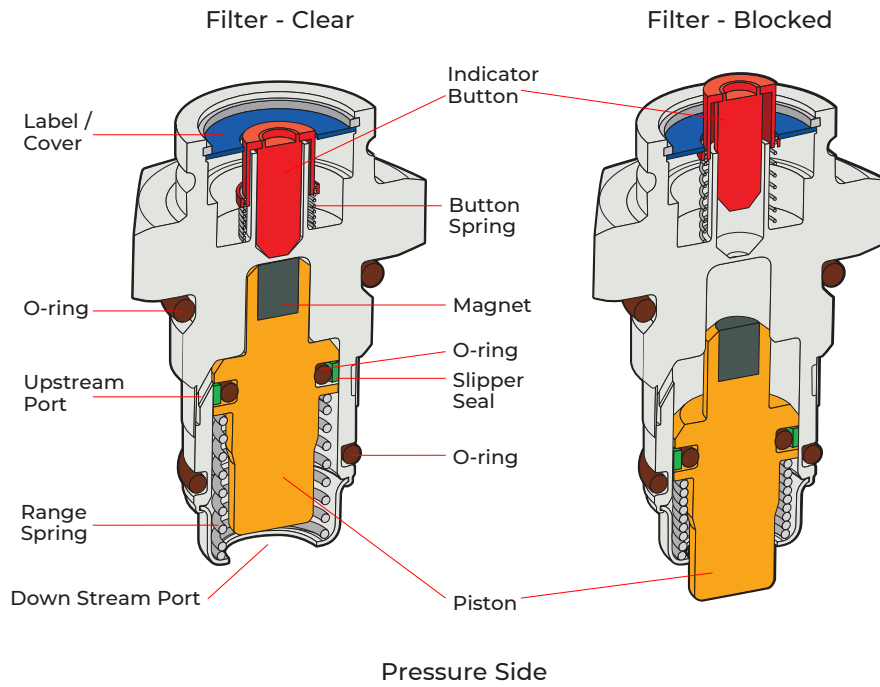

Technical principle of the mechanical indicators:

Differential pressure indicators operate by sensing the ΔP between ports upstream and downstream of the filter element. When the ΔP across the internal piston/magnet assembly reaches a preset value, determined by the range spring, the piston assembly moves downward, reducing the attractive force between the magnet and indicator button.

The indicator button spring then overcomes the reduced magnetic force and releases the button to signal the need for element change. Activation can be visual using a button as shown here or electrical using a microswitch.

A variety of differential pressure indicator models are available. Contact Pall to determine the most appropriate ΔP indicators or switches for your applications.

ISO Cleanliness and Filtration Standards

The Technical Committee that is responsible for developing, drafting and updating standards used by the fluid power industry is ISO/TC131 SC6.

Sampling, contamination analysis and reporting

ISO Number	Subject
ISO 4021	Sampling from system
ISO 4405	Gravimetric analysis
ISO 4406	Contamination coding system
ISO 4407	Counting by microscope
ISO 11171	APC calibration
ISO 11943	On-line calibration of APCs
ISO 11500	Counting using APCs
ISO 16144	Procedures for certifying SRM 2806 calibration material
ISO 21018-1	Monitoring- general principles
ISO 21018-2	Calibrating on-line monitors
ISO 21018-3	Monitoring using the filter/mesh blockage method
ISO 21018-4	Light extinction monitors

Filter and separator evaluation

ISO Number	Subject
ISO 2941	Collapse/Burst test
ISO 2942	Fabrication integrity
ISO 2943	Material compatibility
ISO 3723	End load test
ISO 3724	Flow fatigue of elements
ISO 3968	Flow/pressure drop characteristics
ISO 16860	Differential pressure devices
ISO 16889	Multi-pass test for filter elements
ISO 18237	Water separation performance
ISO 23181	High viscosity flow fatigue
ISO 23369	Cyclic flow Multi-pass

Component and system cleanliness

ISO Number	Subject
ISO 10686	Calculating system cleanliness levels
TR 10949	Achieving and controlling component cleanliness
ISO 12669	Setting system cleanliness levels
ISO 16431	Verifying cleanliness of systems
ISO 16232	Component Cleanliness*
ISO 18409	Extracting particles from hoses
ISO 18413	Sample collection, analysis and data reporting
ISO 23309	Flushing of piping systems

*ISO TC22/SC5 - Road vehicles - Cleanliness of component of fluid circuits.

Why do Components Need to be Clean?

- Fluid systems become more sophisticated and less tolerant to dirt and so controlling and measuring component cleanliness has become a vital part of the manufacturing process.
- Reducing contaminant levels has a positive influence on both Catastrophic and Wear related failures.

Main drivers
Engineering

- Tighter clearances / tolerances*
- Higher degree of surface finish
- Higher operating pressure
- Reduced dimensional footprint

Consequences
Manufacturing

- Cleaner manufactured parts and components
- More efficient washing process
- Cleaner wash-fluids

e.g., 4 µm tolerances on a piston rings
 Source: Mahle



Measure to Control

Throughout the manufacturing process including final assembly, components are subjected to multiple operations that increase component contamination levels.

- Fabrication
- Treatment
- Pre-assembly
- Final assembly
- Transportation
- Storage

The measurement of Component Cleanliness is a critical part of the manufacturing / assembly process control and continuous improvement practice.



Wide range of contaminant sizes - from a few microns to a few millimeters... depending upon components and cleanliness specifications

Contaminant Measurement helps ensure that processes are capable and in control

Component cleanliness is measured to a given **standard**, against a given **specification**, with an appropriate **extraction procedure**

- The **standard** describes how to test a component, and how to report the findings. This is to ensure the test is repeatable and meaningful
- The **specification** is the value of the desired result, the maximum level of contamination allowed, and is specific to the component
- The **extraction procedure** defines the operating parameters to extract contaminants from the component. It is specific to the component design

Built-in contaminants (manufacturing and assembly)

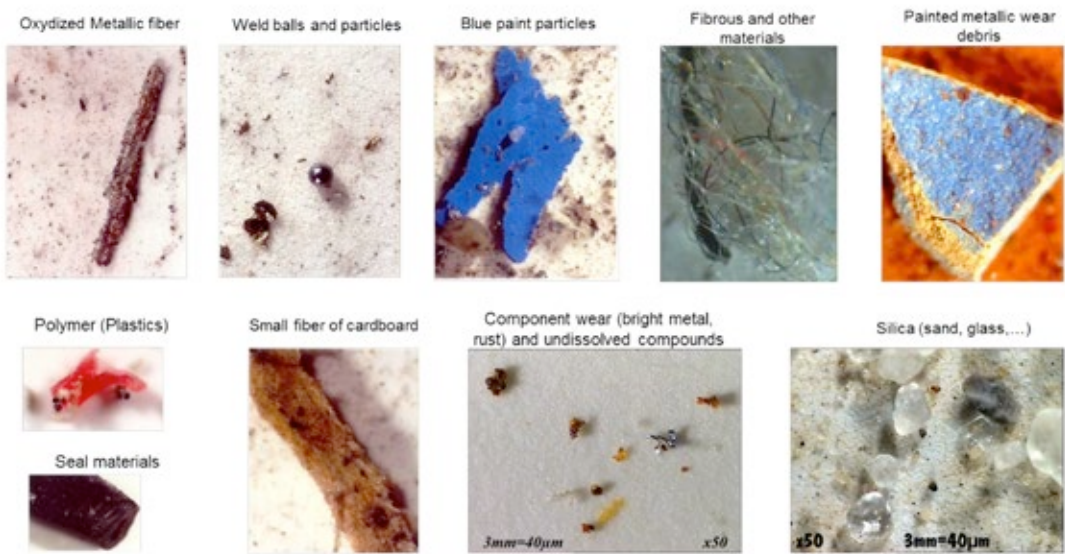

Standards for Component Cleanliness

ISO 16232 – General Overview

Other standards exist:

VDA 19 –

Equivalent to ISO 16232, prevalent in Germany

ISO 18413 –

Hydraulic fluid power – Component cleanliness – Sample collection, analysis and data reporting

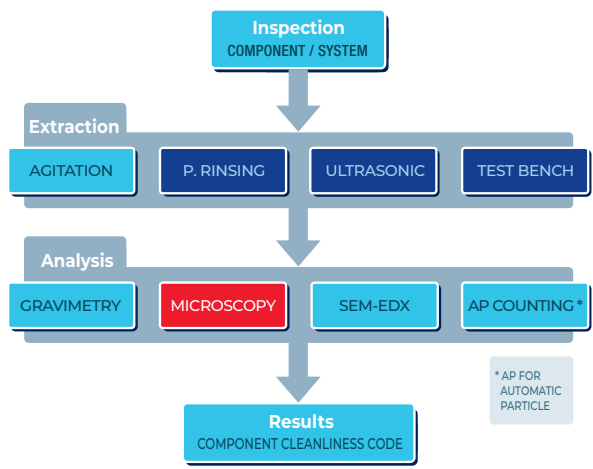

ISO 16232 – Analysis of the Extraction Fluid

Apart from the automatic particle counting method, the 3 techniques used to quantify and qualify solid contaminant levels require capturing contaminants on a filter membrane. This is best achieved by the use of a Cleanliness Cabinet.

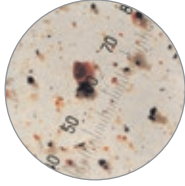

Filter membrane
Photomicrograph showing built-in contaminants captured on a filter membrane after extraction from the component

Technique	Standard equipment	Result
Gravimetry	Laboratory balance	Mass of contaminants
Microscopy	Image analyzer	Particle counting
Microscopy	MEB-EDX*	Nature of contaminants

* Scanning Electron Microscope associated with a X-ray detection system

ISO 16232 – Component Cleanliness Code

Example:

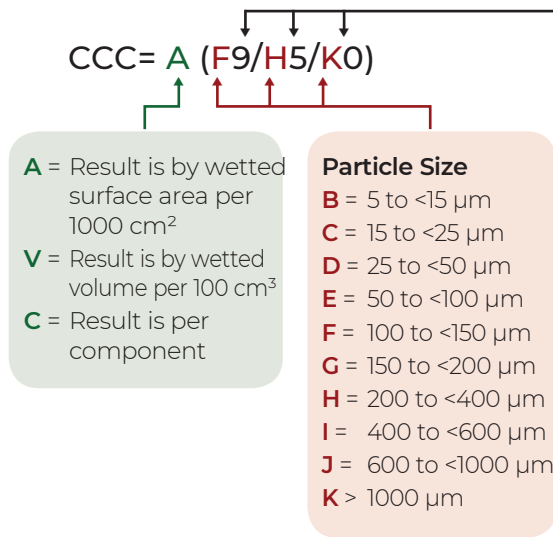

In this example, the result, or required specification is per 1000 cm² of wetted surface area, between 250 and 500 particles in the size range 100 to 150 microns, between 16 and 32 particles in the size range of 200 to 400 microns, and either 0 or 1 particle ≥ 1000 micron.

>	≤	Code
500 x 10 ³	1000 x 10 ³	20
250 x 10 ³	500 x 10 ³	19
130 x 10 ³	250 x 10 ³	18
64 x 10 ³	130 x 10 ³	17
32 x 10 ³	64 x 10 ³	16
~	~	~
250	500	9
130	250	8
64	130	7
32	64	6
16	32	5
8	16	4
4	8	3
2	4	2
1	2	1
0	1	0
0	0	00

Component Cleanliness Management

Regular Component Cleanliness assessments also enable Operators to know whether or not their washing process is under control.

- **Component Cleanliness analyses are more relevant than wash-fluid contamination analyses as they represent exactly what is getting out of the washing machines**
- **Component Cleanliness Results speak by themselves: they are in or out the Specification!**

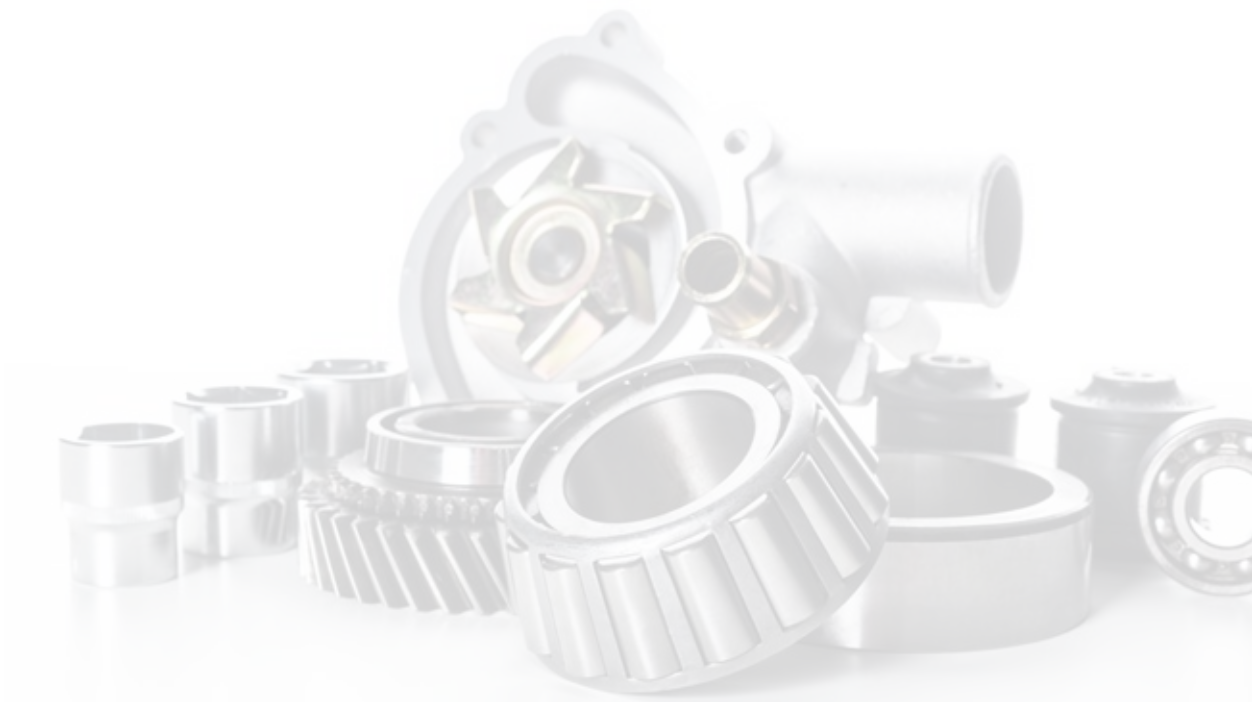
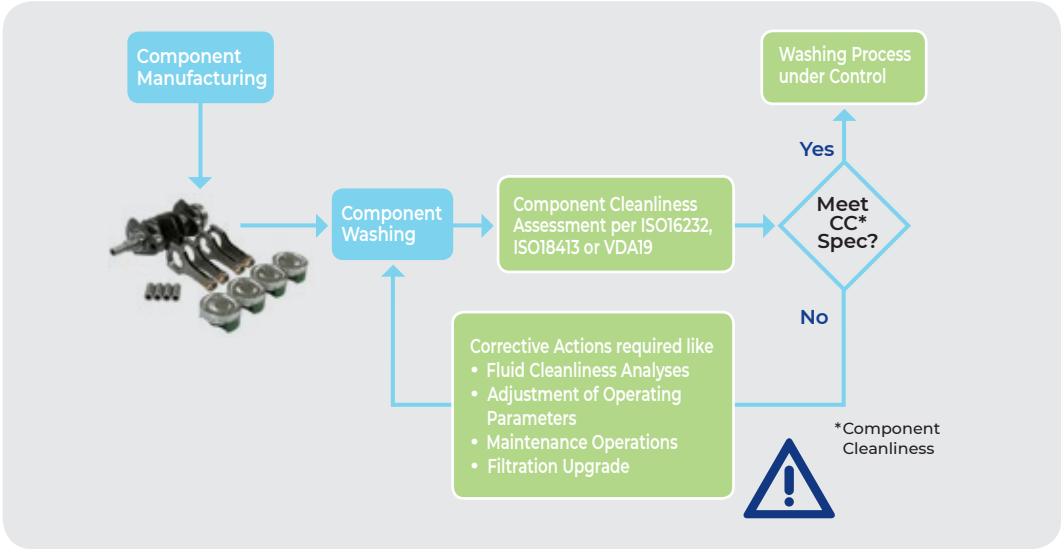

Typical Process Applications (In-Plant)

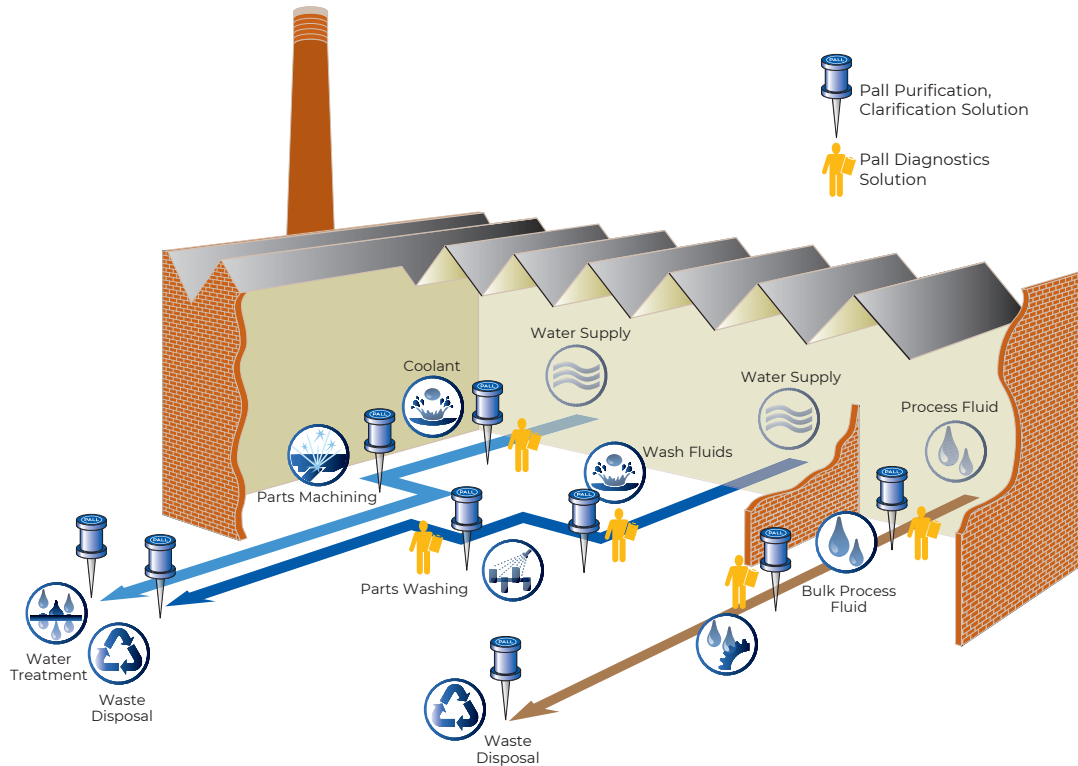

Typical Contaminants vs. Filtration Technologies

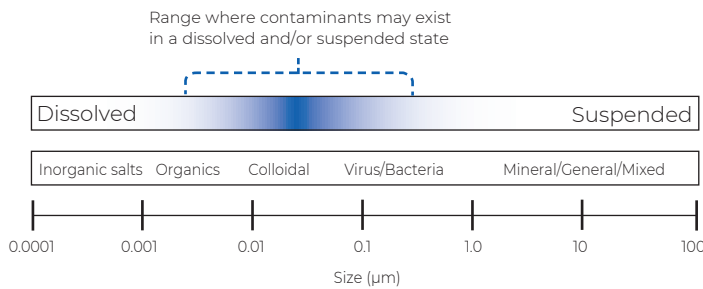

Typical process applications

- Parts-machining
- Parts-washing
- Parts E-coating, painting
- Systems testing and flushing
- Fill Fluids

Typical process fluids

- Industrial water,
- Water based fluids, emulsions
- Light petroleum based fluids, fuels
- Paints, coolants, etc

Typical differences between Process and Hydraulic and Lube applications

- Low viscosity fluids (< 10 cSt)
- Large range of particle sizes (µm – mm)
- Continuous ingress of contaminants into the system
- Higher contamination levels (mg/L)
- Possible presence of bacteria, fungi, etc in aqueous fluids



Typical Process fluid filtration solution

- Depth filter elements (disposable elements)
- Systems (cleanable elements or membranes)

Parts-Machining

Water-based metalworking fluids are used for initial make-up and operating systems. These systems are typically affected by 3 types of contaminants.

- 1. Solid contamination** causes accelerated wear of cutting tools (uncontrolled clearances leading to surface finish degradation of machined components)
- 2. Liquid contamination** by tramp oil in aqueous fluids and water in neat oil accelerates additive consumption, thus

affecting the fluid's physical, chemical and performance characteristics

- 3. Chemical contamination** results in the formation of gels and sludges, caused by the interaction of the fluid and the various contaminants. This reduces service life of the filter and blocks nozzles, etc.

Industrial water (incoming water, boiler feed water, reuse) contains particles, colloids, chlorides and calcium that might otherwise affect fluid stability.



Water-based metalworking fluid treatment



Industrial water treatment



Fluid Cleanliness Management

Customer Benefits

- Life extension of tools, system components and fluids
- Higher machining performance and less machine adjustment
- Improvement of parts surface finish
- Reduction of parts reject rate

Parts-Washing

Industrial water contains particles, colloids, chlorides and calcium that might otherwise affect fluid stability.

Wash fluid initial make-up and operating conditions

- 1. Solid contamination:** solid contamination not entirely under control along the washing process increases component rejection and re-cleans

- 2. Liquid contamination** residual machine tool coolants, honing oils, lubricating oils and greases, affect the wash fluid physical and chemical characteristics. This leads to health and safety concerns (bacteria, fungi) as well as a degradation of the overall washing process.



Wash fluid treatment



Industrial water treatment



Fluid Cleanliness Management

Customer Benefits

- Improved component cleanliness
- Fluid life extension (removal of solids, oil, bacteria)
- Reduction of parts reject rate due to solid contamination
- Reduced maintenance operations due to extended fluid service life and less nozzle blockage
- Compliance with HSE standards

Example of a Typical Process Application: Parts-Washing

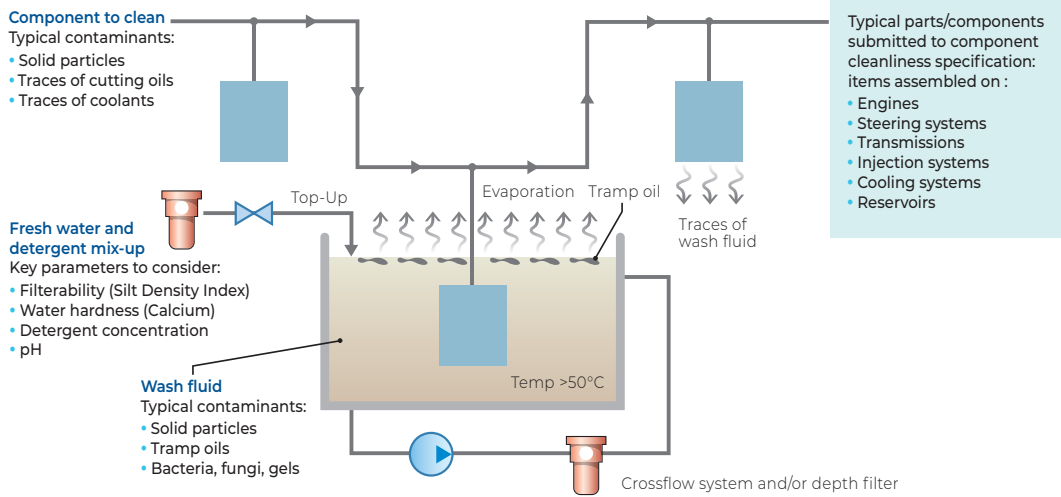

A washing system is an 'open system' submitted to a continuous ingress of solid and liquid contaminants. The washing properties of the fluid must remain efficient throughout its service life – This efficiency results from a very fine balance between fresh water and detergent top-ups, the operating conditions of the wash fluid (chemical and particulate contaminants), the evaporation rate, etc. If these parameters are not under control, then the overall washing process will be affected

Recommendations for the operating conditions of parts-washing fluids

Make-up Water

Water should not be too hard. Care should be taken to not use stagnant water that could have high levels of bacteria. The water quality can be checked with a SDI test, target <2.

Emulsified Oil /Chemical Concentration

The correct concentration level depends on the application:

- 1 to 2% typically for wash fluids,
- 3 to 8% typically for coolant fluids to maintain the correct pH ~9

Free tramp oil

Tramp oil seals off oxygen creating anaerobic conditions for sulphate reducing bacteria that feed on the tramp oils and components of the coolant. Tramp oil causes a de-stabilising or phasing effect in the emulsion, impairing the distribution of oil droplets and wetting characteristics of the fluid. Target <1% tramp oil.

Bacteria and fungus contamination

If the pH drops bacteria can start to grow. The bacteria create acid dropping the pH further, making it easier for more bacteria and fungus to grow. Bacteria are measured in cfu/ml. Target should be below = <104 cfu/ml.



Typical Analyses Performed on Water Based Fluids

Analysis	Description	Unit	Usually applied to technology
TSS *	Total Suspended Solids	mg/L	3,4,5
TDS	Total Dissolved Solids	mg/L	1,2
TOG	Total Oil & Grease	mg/L	3,4
BOD	Biological Oxygen Demand	mg/L	1,2,3,4
COD	Chemical Oxygen Demand	mg/L	1,2,3
pH	Acidity	1 - 14	1,2
TH *	Total Hardness	CaCO₃ mg/L or °F	1,2
Bacteria	Microbiological contamination	cfu/mL *	3,4
Turbidity	Turbidity	NTU **	3,4,5
Conductivity	Conductivity	mS/cm	1,2,3
SDI *	Silt Density Index	1 - > 10	All

* cfu: colony forming unit

** NTU: Nephelometric unit

* See a more detailed description in the following section

Typical Treatment Technologies

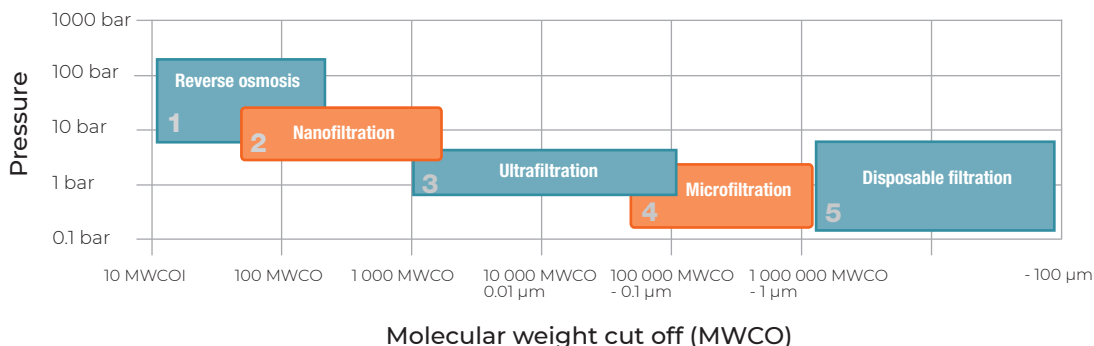

Water Hardness

Hard water is water that has a high mineral content (in contrast with “soft water”). Water hardness is determined by the concentration of positively charged metal ions, such as Ca²⁺ and Mg²⁺ that can cause a build up of contaminant on components (e.g limescale in pipework). Hard water can be a serious issue in industrial installations. For this reason water hardness is monitored to avoid costly breakdowns in water coolers, boilers, cooling towers, and other water handling equipment. In addition, hard water can precipitate soaps in wash and coolant fluids. Rain water and distilled water are soft as they contain few minerals.

Hardness Classification

Classification	Hardness in mg/L Calcium
Soft	0 - 60
Moderately hard	61 - 120
Hard	121 - 180
Very hard	> 181

Typical technical solutions to soften industrial water when required:

- Ion exchange resins
- Micro Filtration and Reverse Osmosis

Total Suspended Solids (TSS)

The TSS analysis is a gravimetric analysis performed using a 0.8 µm 47 mm diameter Nylon membrane. The TSS value is the difference between M2 (gravimetric level of contaminated water sample) and M1 (gravimetric level of pre-filtered water sample).

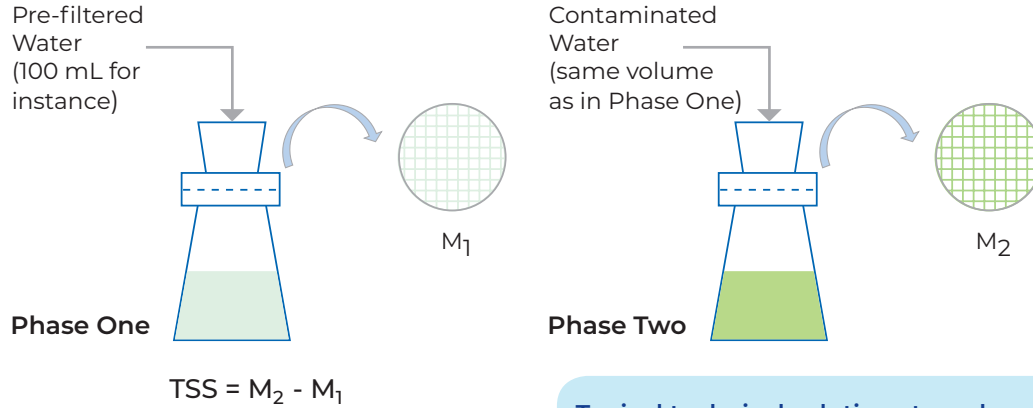

Typical technical solutions to reduce TSS when required:

- Disposable filtration
- Microfiltration (MF) or Ultrafiltration (UF)

Silt Density Index (SDI)

Test method (per ASTM D4189-07)

Test fluid is passed through a 0.45 µm membrane.

The operator records the time [t_i] taken for 500 mL (or 100 mL) of fluid to pass through the membrane when it is new, then after 5, 10 and 15 minutes of filtration.

$$SDI = \frac{1 - t_0/t_i}{T_i} \times 100$$

T_i=15 if t₀/t₁₅ > 0.2
 T_i=10 if t₀/t₁₀ > 0.2
 otherwise, T_i=5 and use t₀/t₅ in the formula

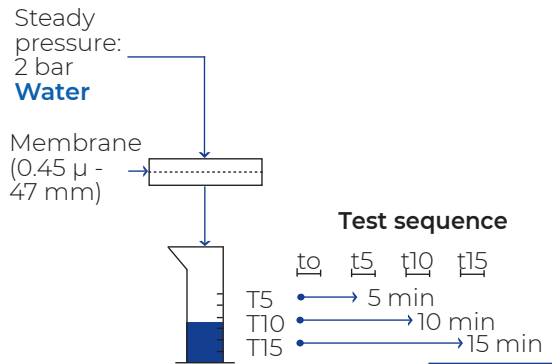

SDI Interpretation

Calculated value	Filtration capabilities
SDI < 3	Lightly fouled water
3 < SDI < 6	Slightly fouled water
SDI > 6	Highly fouled water (expected short service life of filter elements)

Depth Filter Elements

- Wide range of filter product configurations to meet requirements across a variety of applications –

Typical features

- 2" to 6" diameter cartridge geometry
- Gradient pore structure
- Core and coreless designs available depending on the series products
- Absolute rated at 99.9% filtration efficiency with retention ratings typically from 1 to 120 μm
- Large fluid compatibility
- High retention capacity
- High flow density

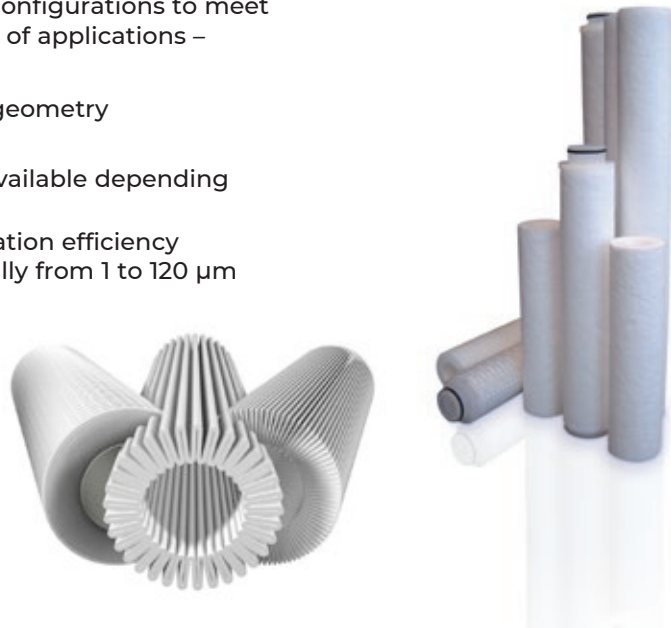

Disposable Filter Elements

Compared to hydraulic and lube filtration products, there is a wide range of filter media configuration for process fluid filtration applications, each designed to achieve the highest performance possible across a large range of operating environments.

Selection Guideline

1	2	3	
●		●	High Ingression rate
		●	High flow rate
	●	●	Presence of gels/colloids
	●	●	High viscosity

Filter Elements



1 Depth filter

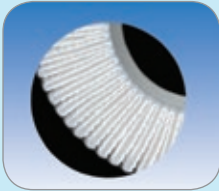

2 Traditional Fan pleat geometry with depth media

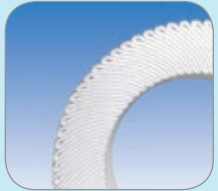

3 Laid-over pleat geometry with depth media

- Typical materials of construction: Polypropylene, Nylon
- Typical filter ratings*: 0.5-150 μm

*based on the modified OSU-F2 single pass test procedure

Pressure drop – Darcy Law (Theory)

$$DP_{\text{Element}} \text{ is proportional to } \frac{F \cdot \eta \cdot \epsilon}{A \cdot K}$$

- Darcy Law – Case Study

Assuming only 1 out of 5 parameters changes each time

Parameter	DP _{Element}
F ↗	↗
η ↗	↗
ε ↗	↗
A ↗	↘
K ↗	↘

- F:** Flow rate
- η:** Viscosity of the fluid
- ε:** Thickness of the filter medium
- A:** Filtration surface area
- K:** Porosity of the filter

Example for a same depth filter series

- A 10" long element will exhibit a 2 times higher DP than a 20" long element
- A 5 μm filter will exhibit a higher DP than a 20 μm filter element

Pressure Drop - Darcy Law (Impact on Initial DP and Service Life)

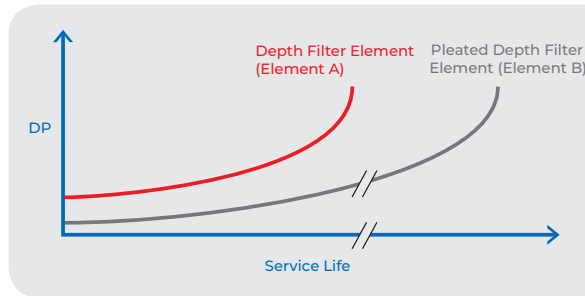

Assuming the 2 elements feature the same size and have the same filter rating, submitted to the same test conditions (modified OSU-F2 test), the pleated melt blown filter (B) will exhibit a much longer service life than the depth filter (A).

Element A:

- Almost same filtration surface area as a bag filter but with much more robust structure and higher dirt holding capacity
- Mainly used as a batch processing filter (paint, E-coat)

Element B:

- Much higher filtration surface area than a bag filter
- Excellent in continuous filtration process and for applications where the fluids exhibit a wide particle size distribution (e.g., parts washing)
- Very efficient where gels are present

Depth Filter Elements

- Wide range of filter product configurations to meet requirements across a variety of applications

Application recommendations

+ Filtration Efficiency	<ul style="list-style-type: none"> • Function testers • Production per batch (base coat - paint) <p style="text-align: center;">1 2</p>	<ul style="list-style-type: none"> • Final washes • Clear coat (paint) • Protection of water based heat exchangers • Filling lines • Protection of RO/UF systems <p style="text-align: center;">1 3</p>
	<ul style="list-style-type: none"> • Coatings (paint formulators) • Primers • Industrial water (pre-filtration - closed systems) <p>Bag filters</p>	<ul style="list-style-type: none"> • Pre washes • General washes • Industrial water (pre-filtration - open systems) <p style="text-align: center;">1 3</p>
-	- Dirt Holding Capacity (Service Life) +	

Filter Elements



1 Depth filter



2 Traditional Fan pleat geometry with depth media



3 Laid-over pleat geometry with depth media

Process Fluid Filter Performance Test

(modified OSU-F2 test)

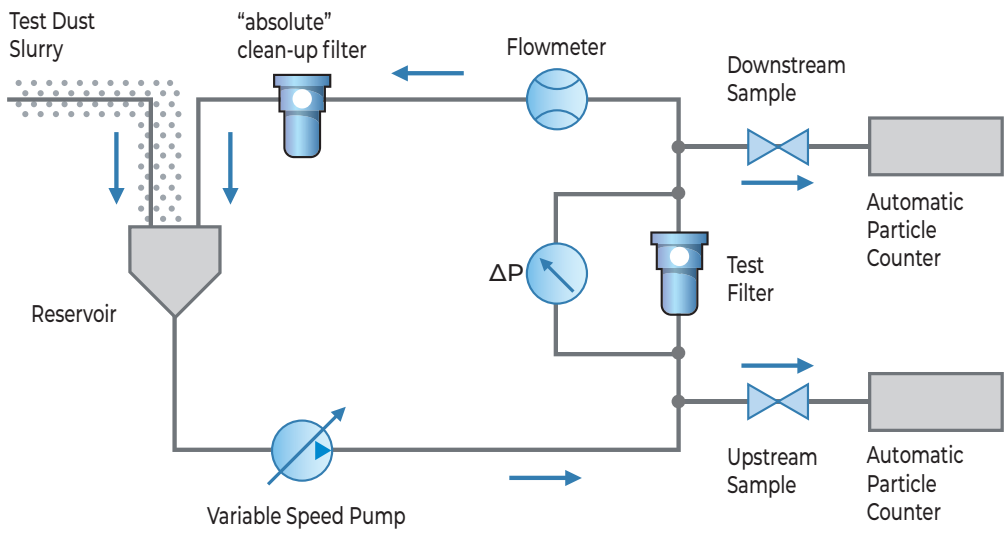

The modified OSU-F2 test is an accelerated single pass test that quantifies filter element performance in terms of filtration efficiencies (measured as Beta Ratios) under standardized test conditions.

The industry mainly relies on Beta Ratios > 5,000.

The modified OSU-F2 Single-Pass test protocol is different from the ISO16889 Multi-Pass Test protocol used to test hydraulics and lube filters.

Media and Structure

Depth filter elements

- Media layer 6X thicker (long life)
- Graded pore construction
- Absolute rated

- Thin media layer (short life)
- Non-fixed pore construction
- Nominally rated

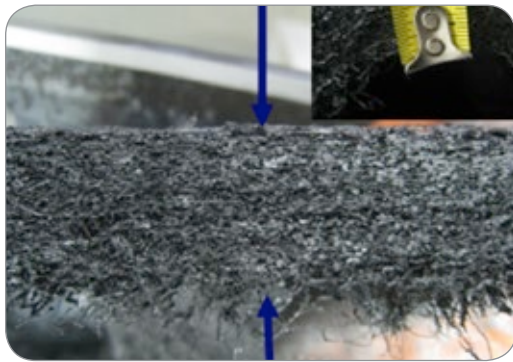

Depth Filter

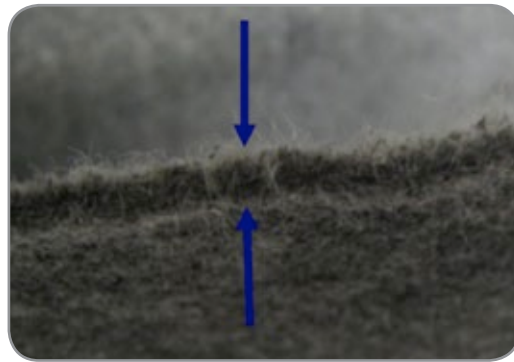

Bag Filter



Bag Filter

- Lower cost
- Wide range of media and sizes
- Poorer filtration efficiency
- Lower dirt holding capacity
- No mechanical resistance, leading to channeling effect

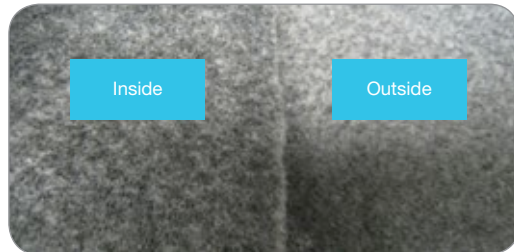

Non-fixed pore construction of bag filter media.



Depth Filter

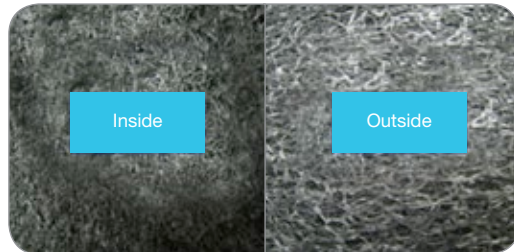

Graded pore construction of depth filter media increases dirt holding capacity and filter service life.



Surface Area and Dirt Capacity

Bag filters vs Depth filter elements

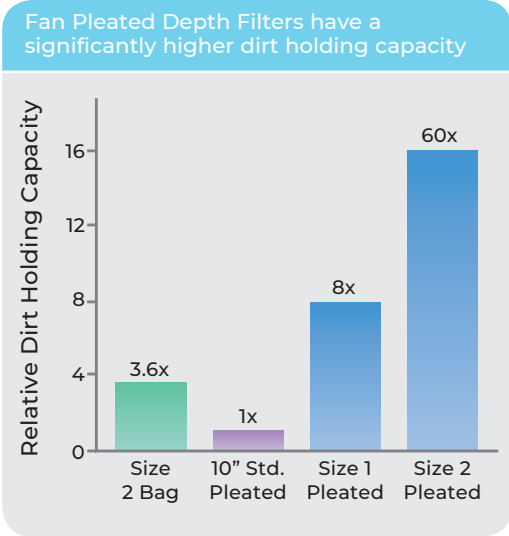
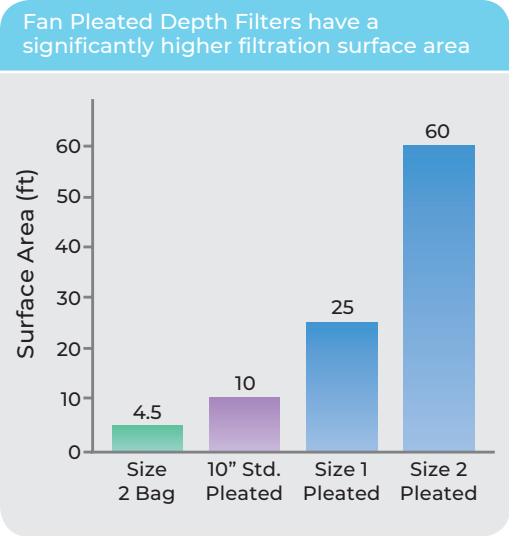

These 2 graphs compare high efficiency bag filters, 10" standard pleated filter cartridges and Pleated Depth filter elements. This comparison is typical for most of the filter grades.

Pall Fluid Cleanliness Management Products



Pall Athalon™ Filters

The Ultimate in Filter Design for Hydraulic and Lube applications

Athalon™

Proprietary Wave-Shaped Pleat Geometry

- Maximizes filtration area
- Increases flow handling capability
- Reduces filter element size
- Creates uniform flow distribution through the filter element

Stress-Resistant Filter Medium

- Improves fluid cleanliness consistency
- Improves performance in “real world” conditions

Anti-Static Construction

- Minimizes triboelectric charging and electrostatic discharge
- Prevents damage to filter element, housing, or fluid due to static discharge

Coreless/Cageless Construction

- 60 % lighter than comparable filter elements with cores
- Reduces disposal costs (filter elements are incinerable, shreddable or crushable)

In-To-Out Flow Path

- Reduces the chance of cross contamination during filter element change

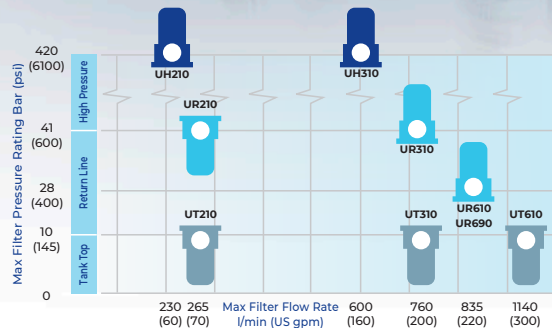

High pressure, return line and intank Athalon filter housing designs



Pall Supralon™ Filter Elements

High performance elements for hydraulic and lubrication fluids

- Replacement filter elements for Pall Ultipor® and Coralon® design
- Stress and static charge resistant technology
- Beta $\beta_{x(c)}$ >2000 rated performance
- Long service life



Fast System Clean-up To Achieve Desired Fluid Cleanliness Levels

Supralon Filters have a Beta ≥ 2000 rating for superior control of particulate contaminants

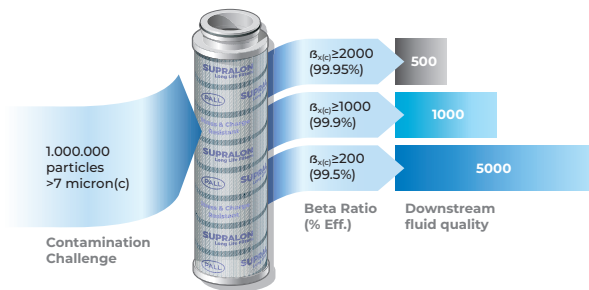

Supralon Filters

- 2X better particle removal efficiency compared to $\beta_{x(c)} \geq 1000$ rated filters and 10X better efficiency than common $\beta_{x(c)} \geq 200$ rated filters
- Significantly fewer passes required to reach target cleanliness level
- Reduces equipment maintenance and unscheduled downtime costs

Protecting the Fluid, Filter, And Other Components From Static Discharge

- Supralon filters incorporate a novel outer wrap, designed to minimize static charge build-up in the element
- Anti-static design dramatically reduces damaging static charge generation compared to conventional lube and hydraulic filter elements
- Static charge resistance is a standard feature included across the entire Supralon product range



Pall Diagnostic and Monitoring Equipment

Whatever your applications in hydraulics or lubrication, we've got the technology suitable to monitor the cleanliness levels of your fluids!

Pall Cleanliness Monitor (PCM) Mesh Blockage Technology

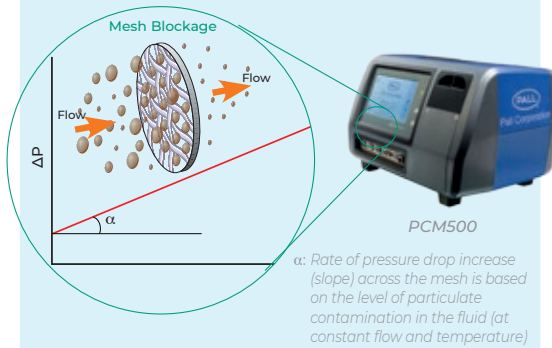

Provide an assessment of system fluid cleanliness

- Proven mesh blockage technology
- On-line and off-line modes of operation
- Results not affected by free water or undissolved air contamination
- Designed for use with dark or cloudy fluids
- ISO 4406, or AS4059 (NAS1638) data output
- Water sensor option

Water Sensors (WS Series) Capacitance Technology

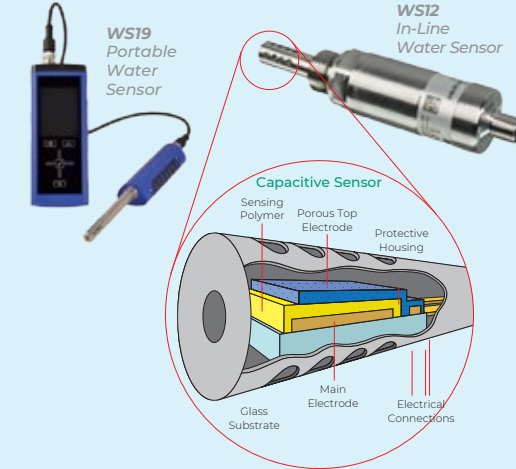

The electrical resistance of the dielectric polymer changes as the relative humidity changes. The water sensor probe is protected to avoid erratic results from solid contaminants settling on the porous top electrode.

Pall Reservoir Air Filters

Different designs for the same objective:

- Provide optimum protection against airborne contamination ingress into vented fluid systems
- Reduce operating costs and improve system performance

0293 series



- Non-corroding reservoir breather filter
- Filter rating: 3 μm in air

3050 series



- Disposable non-corroding reservoir breather filter
- Filter rating: 1, 2 and 4 μm in air

PFD series



- Reservoir vent filter/dryer specially designed for systems sensitive to water ingress
- Filter rating: 1 μm in air

Pall Fluid Conditioning Purifiers

Over 60 years experience in dewatering hydraulic, lubricating and dielectric oils

Pall Corporation has continuously advanced the state-of-the-art in fluid clarification and purification through the development of products that remove water and gas contaminants using vacuum dehydration technology.

Different models have been developed to meet specific applications in the Oil and Gas, Power and Industrial Lube and Hydraulics markets.

Pall Purifiers remove:

- 100% of free water and entrained gases
- Up to 80% dissolved water and gasses at 100% ambient RH; >80% at lower ambient RH
- Solid contaminants

With most models this is achieved without the need for a heater to warm-up the fluid before treatment.

Pall Purifiers provide a wide range of opportunities for cost savings including:

- Increased equipment uptime and improved machine performance
- Reduced component replacement costs
- Reduced maintenance labor costs
- Lower oil replacement and disposal costs



HDP10

Flow range:

37.8 L/min
(10 US gpm)

Maximum viscosity:

1,000 cSt



HNP076

Flow range:

70 L/min
(18.5 US gpm)

Maximum viscosity:

700 cSt



HNP023

Flow range:

22 L/min (6 US gpm)

Maximum viscosity:

700 cSt

Other models / variants are available please consult Pall.

Removing free water is never enough!

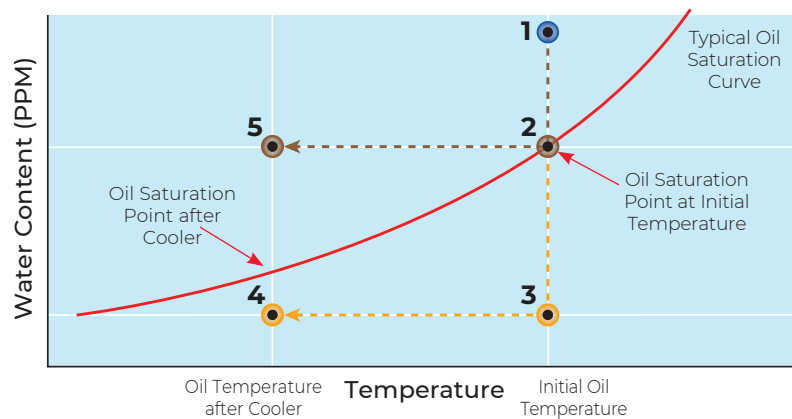

- 1 Initial water content is above saturation (free water).
- 2 Maximum water removal capability of "free water removal" devices (coalescers, centrifuges, etc.) is to the oil's saturation point.
- 3 Water content achieved with mass transfer dehydration is significantly below the oil's saturation point.
- 4 Water content achieved with mass transfer dehydration remains below the oil's saturation point even after oil is cooled. This prevents the formation of harmful free water.
- 5 If only free water is removed at initial temperature, when oil is cooled the amount of harmful free water in the oil can increase significantly.

Pall Melt Blown Filter Cartridges for Water, Chemicals, and Process Fluids

What are “melt blown” media?

The term “melt blown” means the filter has been manufactured using a computer controlled process where polymeric fibers are collected in a uniform or graded pore structure around a molded core.

Pall melt blown filters come in a wide variety of filter medium materials and configurations designed to suit the needs of many differing process applications.

Typical medium materials used are Polypropylene, Nylon and Polyphenylene Sulphide (PPS), which give the melt blown range an extremely broad chemical compatibility and temperature range up to 204 °C.

Pall manufactures these products in two forms:

Continuously Extruded Fiber technology – where the continuously extruded fine fibers produce a highly porous, high strength matrix with consistent filter performance. Products such as Profile®, Profile UP, and the larger diameter Ultipleat® High Flow and Coreless series (for use in high flow applications) are examples of process filters made with this technology.

CoLD® Fiber technology – where the micro-thin fine fibers are interlinked and thermally bonded with large diameter support fibers to increase mechanical strength and lengthen service life. The Nexis® product range and, for higher flows, the Marksman™ series are products made with this technology.

Melt blown media configurations

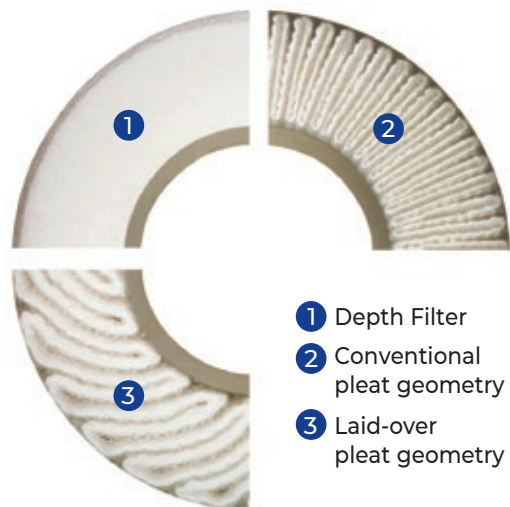

CoLD® Fiber technology

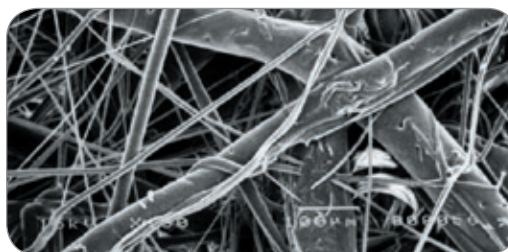

Typical applications

Parts washing: Cleaner fluids mean cleaner components giving less chance of component rejection and re-cleans

Machine tools: Cleaner fluids prevent nozzle clogging (reducing the machine down time), reduce tool wear, improve surface finishes, and give longer fluid service life

Rolling mills: Cleaner fluids reduce “stickers” and “inclusions” that can affect the surface finish or perforate foil products. Foils can also be produced thinner with a resultant cost saving

Pulp and Paper mills: Cleaner fluids protect spray nozzles to reduce sheet breaks, improve sheet quality and consistency, and increase running speed and machine reliability

Rotating equipment: Clean flushing fluids greatly reduce premature seal failure on packing and flushing style mechanical seals

Bulk Transfer: The specified fluid cleanliness is maintained by consistent single-pass removal of contaminants during transfer from bulk storage to point of use

Grinding Honing: Cleaner fluids improve surface finish and increase grinding wheel life, leading to less downtime, fewer reworked pieces, and more production



Varnish Removal Filtration Unit

Description

The SPV and VRFII series are designed to offer users the most cost effective solution to remove varnish from their hydraulic and lubricating oils. They use Pall's SUPRADisc™ adsorptive lenticular filter media that trap varnish within filtration media through weak molecular forces

*VRFII series
(without
water
cooler)*



Fluid degradation and formation of varnish

Varnish results from high molecular-weight compounds formed by thermo-oxidative degradation of lubricants and hydraulic fluids.

Varnish appears as sticky, thin deposits coating critical surfaces throughout the fluid system.

Varnish on a valve spool, for example, can lead to:

- Slow, inaccurate and unstable response
- Spool and pumps jamming
- Solenoid burnout

SPV series

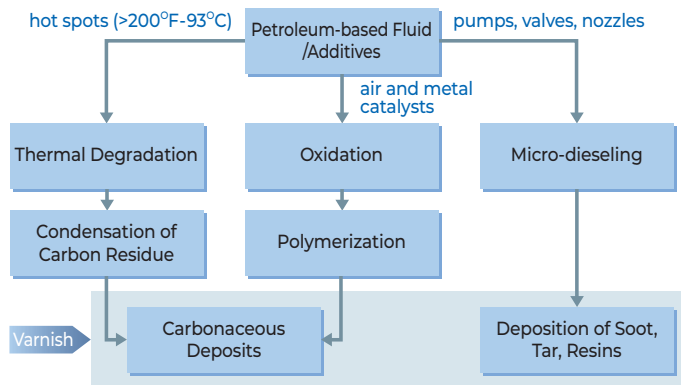

Influencing factors

- Heat, hot spots (e.g. pumps, bearings)
- Machine load and duty cycles
- Electrostatic discharge (filters)
- Adiabatic compression and collapse of entrained air in high pressure areas e.g. high pressure pump inlets

SUPRADisc filter element technology

Medium construction

Cellulose fibers-creating a porous filtration matrix for

- Integration of additives, (e.g. Perlite, Diatomaceous earth, activated carbon)
- Providing strength and handling
- Surface charge modification
- Adsorption
- Burst strength

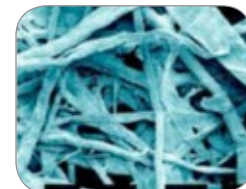

Energy Transition – The Road to Net Zero

We are committed to helping advance the production of green hydrogen, biofuels, plastics recycling and carbon capture, utilizing a wide range of separation and purification solutions. Pall also supports the high growth electric vehicle and associated battery production sector as well as the onshore and offshore wind energy.

The Paris Agreement and the Glasgow Climate Pact set out the global framework for countries to reduce greenhouse gas emissions and reach out net zero by mid-century, pursuing a 50% reduction by 2023. To achieve these goals, we need to decarbonize across every sector.

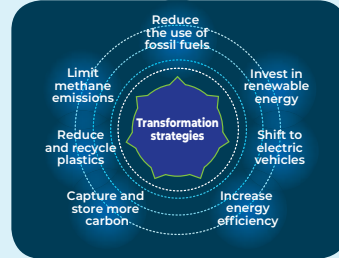

Pall Filtration Solutions for Wind Turbines

Together we deliver Wind Energy powered by innovation

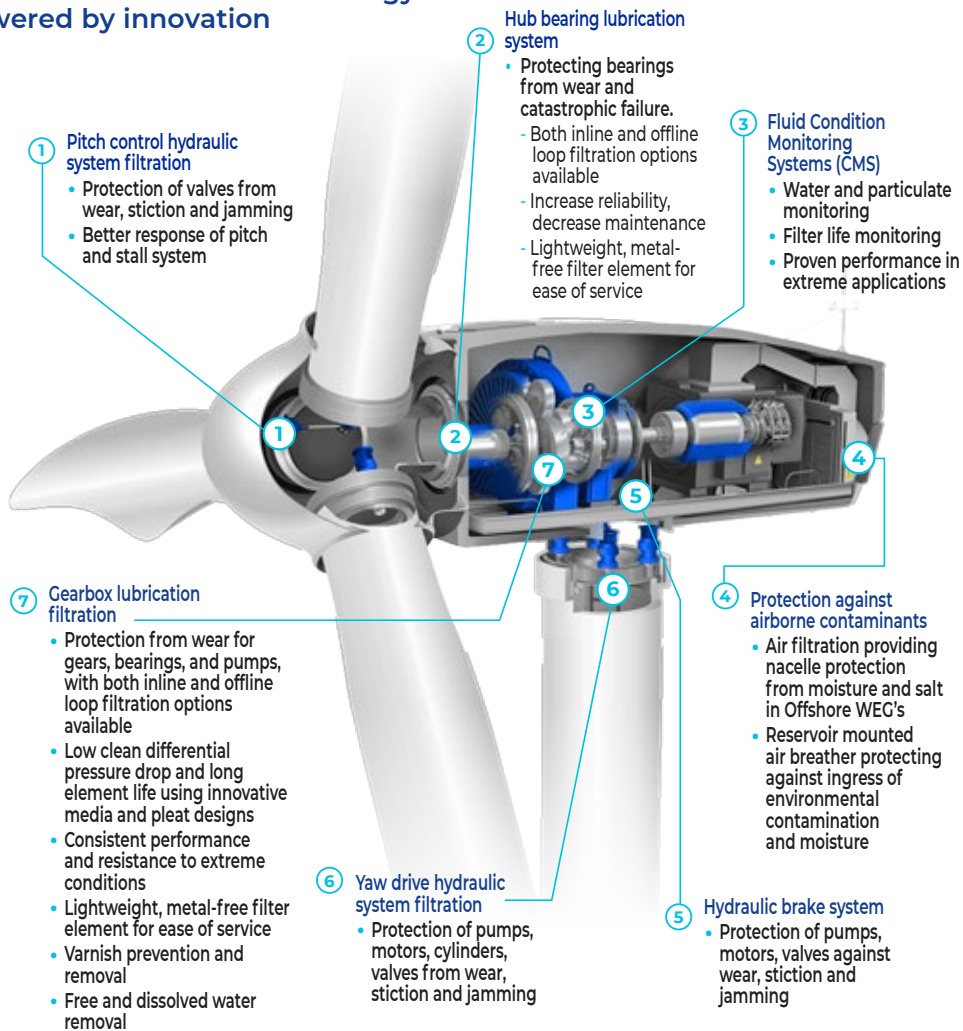

Pall Rental and Services

Fast, Flexible and CAPEX Free

Across a broad range of applications in the Industry, we explore ways to help you maintain – even improve performance and productivity in

- Particulate filtration
- Water removal from petroleum-based fluids
- Varnish removal from hydraulic oils
- Fluid analysis and monitoring
- Metallic Filter cleaning services
- Trainings on Contamination and Filtration fundamentals

Typical rental fleet available in different countries

Contact our local sales representative – many more filter carts available



Contamination Monitor (PCM)



Purifier (HNP)



SUPRAdisc Cart (VRFII cart)



Water Sensor (WS)

Our Flexibility and Availability, Your Success



PALL CORPORATION

Corporate Headquarters

Port Washington, NY, USA
+1-800-717-7255 toll free (USA)
+1-516-484-5400 phone

European Headquarters

Fribourg, Switzerland
+41 (0)26 350 53 00 phone

Asia-Pacific Headquarters

Singapore
+65 6389 6500 phone

Visit us on the Web at www.pall.com

Contact us at www.pall.com/contact

Pall Corporation has offices and plants throughout the world. To locate the Pall office or distributor nearest you, visit www.pall.com/contact.

The information provided in this literature was reviewed for accuracy at the time of publication. Product data may be subject to change without notice. For current information consult your local Pall distributor or contact Pall directly.

IF APPLICABLE Please contact Pall Corporation to verify that the product conforms to your national legislation and/or regional regulatory requirements for water and food contact use.

© Copyright 2023, Pall Corporation. Pall, , Athalon, SUPRADisc, CoLD, Marksman, Nexis and Profile are trademarks of Pall Corporation. are trademarks of Pall Corporation.
® Indicates a trademark registered in the USA.

PISEMBENa
June 23